

# ECX-1400/1300 USER Manual

8<sup>th</sup> Gen Intel® Xeon®/Core™ i7/i5/i3 Expandable Fanless System  
Workstation-grade, 6 GigE LAN w/4 PoE<sup>+</sup>, 4 SSD Tray, 2 PCI/PCIe Slot

# Record of Revision

---

Version	Date	Page	Description	Remark
0.10	2019/01/09	All	Preliminary Release	
1.00	2019/01/15		Official Release	
1.10	2019/04/02	66	Update	
2.00	2019/07/24	v, 1, 2, 3, 5, 7, 9, 11, 13, 17, 19, 21, 23, 25, 27	Update	
2.10	2021/03/22	3, 5, 7, 9, 11, 13, 15, 17, 19, 21, 23, 25, 42	Update	
2.20	2023/01/18	45, 47, 52, 85	Update	
2.30	2023/05/31	All	Update	

# Disclaimer

This manual is released by Vecow Co., Ltd. for reference purpose only. All product offerings and specifications are subject to change without prior notice. It does not represent commitment of Vecow Co., Ltd. Vecow shall not be liable for direct, indirect, special, incidental, or consequential damages arising out of the use of the product or documentation or any infringements upon the rights of third parties, which may result from such use.

# Declaration of Conformity

**FCC** This equipment has been tested and found to comply with the limits for a Class A digital device, pursuant to part 15 of the FCC Rules. These limits are designed to provide reasonable protection against harmful interference when the equipment is operated in a commercial environment. This equipment generates, uses, and can radiate radio frequency energy, and if it is not installed and used in accordance with the instruction manual, it may cause harmful interference to radio communications. Operation of this equipment in a residential area is likely to cause harmful interference in which case the user will be required to correct the interference at his own expense.

**CE** The products described in this manual complies with all applicable European Union (CE) directives if it has a CE marking. For computer systems to remain CE compliant, only CE-compliant parts may be used. Maintaining CE compliance also requires proper cable and cabling techniques.

# Copyright and Trademarks

This document contains proprietary information protected by copyright. No part of this publication may be reproduced in any form or by any means, electric, photocopying, recording or otherwise, without prior written authorization by Vecow Co., Ltd. The rights of all the brand names, product names, and trademarks belong to their respective owners.

# Order Information

Part Number	Description
ECX-1420	ECX-1400, 6 GigE LAN with 4 PoE <sup>+</sup> , 1 PCIe x16, 1 PCIe x4, 4 SSD Tray, 6 USB 3.1, 4 COM, 3 SIM, 32 Isolated DIO
ECX-1411	ECX-1400, 6 GigE LAN with 4 PoE <sup>+</sup> , 1 PCIe x16, 1 PCI, 4 SSD Tray, 6 USB 3.1, 4 COM, 3 SIM, 32 Isolated DIO
ECX-1402	ECX-1400, 6 GigE LAN with 4 PoE <sup>+</sup> , 2 PCI, 4 SSD Tray, 6 USB 3.1, 4 COM, 3 SIM, 32 Isolated DIO
ECX-1320	ECX-1300, 2 GigE LAN, 1 PCIe x16, 1 PCIe x4, 4 SSD Tray, 6 USB 3.1, 4 COM, 3 SIM, 16 GPIO
ECX-1311	ECX-1300, 2 GigE LAN, 1 PCIe x16, 1 PCI, 4 SSD Tray, 6 USB 3.1, 4 COM, 3 SIM, 16 GPIO
ECX-1302	ECX-1300, 2 GigE LAN, 2 PCI, 4 SSD Tray, 6 USB 3.1, 4 COM, 3 SIM, 16 GPIO
ECX-1400 GTX1070	ECX-1400 with NVIDIA <sup>®</sup> GeForce <sup>®</sup> GTX 1070, 6 GigE LAN with 4 PoE <sup>+</sup> , 4 SSD Tray, 6 USB 3.1, 4 COM, 3 SIM, 32 Isolated DIO
ECX-1300 GTX1070	ECX-1300 with NVIDIA <sup>®</sup> GeForce <sup>®</sup> GTX 1070, 2 GigE LAN, 4 SSD Tray, 6 USB 3.1, 4 COM, 3 SIM, 16 GPIO
ECX-1410 GTX1050	ECX-1400 with NVIDIA <sup>®</sup> GeForce <sup>®</sup> GTX 1050, 6 GigE LAN with 4 PoE <sup>+</sup> , 1 PCIe x4, 2 SSD Tray, 6 USB 3.1, 4 COM, 3 SIM, 32 Isolated DIO
ECX-1401GTX1050	ECX-1400 with NVIDIA <sup>®</sup> GeForce <sup>®</sup> GTX 1050, 6 GigE LAN with 4 PoE <sup>+</sup> , 1 PCI, 2 SSD Tray, 6 USB 3.1, 4 COM, 3 SIM, 32 Isolated DIO
ECX-1310 GTX1050	ECX-1300 with NVIDIA <sup>®</sup> GeForce <sup>®</sup> GTX 1050, 2 GigE LAN, 1 PCIe x4, 2 SSD Tray, 6 USB 3.1, 4 COM, 3 SIM, 16 GPIO
ECX-1301 GTX1050	ECX-1300 with NVIDIA <sup>®</sup> GeForce <sup>®</sup> GTX 1050, 2 GigE LAN, 1 PCI, 2 SSD Tray, 6 USB 3.1, 4 COM, 3 SIM, 16 GPIO

## CPU List

Series	CPU	Cores	GHz	TDP (W)	CPU	Cores	GHz	TDP (W)	ECC RAM
Intel® Xeon®	E-2176G	6	4.6	80	E-2278GE	8	4.7	80	Yes
					E-2278GEL	8	3.9	35	
	E-2124G	4	4.5	71	E-2226GE	6	4.6	80	
Intel® Core™	i7-8700	6	4.6	65	i7-9700E	8	4.4	65	N/A
	i7-8700T	6	4	35	i7-9700TE		3.8	35	
	i5-8500	6	4.1	65	i5-9500E	6	4.2	65	
	i5-8500T	6	3.5	35	i5-9500TE		3.6	35	
	i3-8100	4	3.6	65	i3-9100E	4	3.7	65	Yes
	i3-8100T	4	3.1	35	i3-9100TE		3.2	35	

## Optional Accessories

Part Number	Description
DDR4 32G	Certified DDR4 32GB 2666MHz RAM
DDR4 16G	Certified DDR4 16GB 2666/2400/2133MHz RAM
DDR4 8G	Certified DDR4 8GB 2666/2400/2133MHz RAM
DDR4 4G	Certified DDR4 4GB 2666/2400/2133MHz RAM
PWA-160WB-WT	160W, 24V, 85V AC to 264V AC Power Adaptor with 3-pin Terminal Block (7.62mm pitch), Wide Temperature -30°C to +70°C
PWA-280WB-WT	280W, 24V, 85V AC to 264V AC Power Adaptor with 3-pin Terminal Block (7.62mm pitch), Wide Temperature -30°C to +70°C
PWS-360W	360W, 28.8V, 90 to 132V AC/180 to 264V AC (selected by switch) Power Supply
PWS-480W-WT	480W, 24V, 90V AC to 305V AC Power Supply, Wide-Temp, IP65
VESA Mount	VESA Mounting Kit
DIN-RAIL Kit	DIN Rail and VESA Mounting Kit
TMK2-20P-100	Terminal Block 20-pin to Terminal Block 20-pin Cable, 100cm
TMK2-20P-500	Terminal Block 20-pin to Terminal Block 20-pin Cable, 500cm
TMB-TMBK-20P	Terminal Board with One 20-pin Terminal Block Connector and DIN-Rail Mounting
4G Module	Mini PCIe 4G/GPS Module with Antenna
WiFi & Bluetooth	WiFi & Bluetooth Module with Antenna

# Table of Contents

<b>CHAPTER 1</b>	<b>GENERAL INTRODUCTION</b>	<b>1</b>
1.1	Overview	1
1.2	Features	2
1.3	Product Specification	3
1.3.1	Specifications of ECX-1420	3
1.3.2	Specifications of ECX-1411	5
1.3.3	Specifications of ECX-1402	7
1.3.4	Specifications of ECX-1320	9
1.3.5	Specifications of ECX-1311	11
1.3.6	Specifications of ECX-1302	13
1.3.7	Specifications of ECX-1400 GTX1070	15
1.3.8	Specifications of ECX-1300 GTX1070	17
1.3.9	Specifications of ECX-1410 GTX1050	19
1.3.10	Specifications of ECX-1401 GTX1050	21
1.3.11	Specifications of ECX-1310 GTX1050	23
1.3.12	Specifications of ECX-1301 GTX1050	25
1.4	Supported CPU List	27
1.5	Mechanical Dimension	27
1.5.1	Dimensions of ECX-1420	27
1.5.2	Dimensions of ECX-1411	28
1.5.3	Dimensions of ECX-1402	28
1.5.4	Dimensions of ECX-1320	29
1.5.5	Dimensions of ECX-1311	29
1.5.6	Dimensions of ECX-1302	30
1.5.7	Dimensions of ECX-1400 GTX1070	30
1.5.8	Dimensions of ECX-1300 GTX1070	31
1.5.9	Dimensions of ECX-1410 GTX1050	31
1.5.10	Dimensions of ECX-1401 GTX1050	32
1.5.11	Dimensions of ECX-1310 GTX1050	32
1.5.12	Dimensions of ECX-1301 GTX1050	33

<b>CHAPTER 2</b>	<b>GETTING TO KNOW YOUR ECX-1400/1300</b>	<b>34</b>
2.1	Packing List	34
2.2	Front Panel I/O Functions	36
2.3	Rear Panel I/O & Functions	43
2.4	Main Board Expansion Connectors	52
2.5	Main Board Jumper Settings	63
2.6	Ignition Control	67
<b>CHAPTER 3</b>	<b>SYSTEM SETUP</b>	<b>70</b>
3.1	How to Open Your ECX-1400/1300	70
3.2	Installing CPU	73
3.3	Installing DDR4 SO-DIMM Modules	80
3.4	Installing Mini PCIe Card	81
3.5	Installing Antenna Cable	82
3.6	Installing CFast Card	83
3.7	Installing SIM Card	84
3.8	Installing PCI/PCIe Card	85
3.9	Installing SSD/HDD	87
3.10	Installing M.2	89
3.11	Mounting Your ECX-1400/1300	90
<b>CHAPTER 4</b>	<b>BIOS SETUP</b>	<b>92</b>
4.1	Entering BIOS Setup	92
4.2	Main	93
4.3	Advanced	93
4.4	Chipset	104
4.5	Security	109
4.6	Boot	111
4.7	Save & Exit	112

<b>APPENDIX A : Isolated DIO Guide</b>	<b>113</b>
<b>APPENDIX B : Software Functions</b>	<b>119</b>
<b>APPENDIX C : RAID Functions</b>	<b>123</b>
<b>APPENDIX D : Power Consumption</b>	<b>129</b>
<b>APPENDIX E : Supported Memory &amp; Storage List</b>	<b>134</b>



# 1

## GENERAL INTRODUCTION

### 1.1 Overview

Vecow ECX-1400/1300 Series is a workstation-grade expandable Fanless Embedded System. LGA1151 Socket supports workstation-grade 8-core 9th Generation Intel® Xeon®/Core™ i7/i5/i3 processor (Coffee Lake Refresh) running with workstation-grade Intel® C246 chipset, dual channel DDR4 2666MHz up to 64GB ECC memory, advanced Intel® UHD Graphics 630 supporting DirectX 12, OpenGL 4.5, OpenCL 2.0 API, and up to Ultra HD 4K resolution, ECX-1400/1300 delivers new generation CPU & chipset performance, power efficiency, and graphics performance; Powered by optional NVIDIA® GeForce® GTX 1070 or NVIDIA® GeForce® GTX 1050 graphics engine, Vecow ECX-1400/1300 series GTX1070/GTX1050 GPU Computing System boosts leading system performance by CUDA core computing; Multiple 10G SuperSpeed USB 3.1 Gen 2 (10Gbps), PCIe 3.0 (8GT/s), SATA III (6Gbps), USB 3.1 (5Gbps), PoE (1Gbps) LAN, GigE LAN (1Gbps) and wireless connections make seamless real-time high-speed data conveying possible.

Fanless -40°C to 75°C operating temperature, multiple VGA, DVI, HDMI and DisplayPort display interfaces support up to 7 independent displays and 8K resolution, 6 GigE LAN ports with 4 IEEE 802.3at (25.5W/48V) PoE<sup>+</sup> without additional power connections, 6 external USB 3.1 connections, 4 front-access 2.5" SSD/HDD trays support RAID 0, 1, 5, 10 data protection, 3 SIM sockets for multiple WiFi, 4G, 3G, LTE, GPRS or UMTS wireless data transfer, 1 front-access CFast socket, 2 SATA III support software RAID function, 4 COM RS-232/422/485, 1 M.2 for storage, 1 M.2 expansion, 2 Mini PCIe/mSATA expansion, 2 PCI/PCIe expansion slot supporting up to 200W powder budget, 32 Isolated DIO, 6V to 36V wide range power input with 80V surge protection, configurable ignition power control, smart remote management features, remote power switch, EN50155 and EN50121-3-2 compliant, optional full function SUMIT A, B expansion supports multiple SIM sockets, 10GigE RJ45 or 10G SPF+ Fiber connections, Vecow ECX-1400/1300 Expandable Embedded Workstation serves compact integrated functions, flexible expansion features and optimized system operation for any embedded applications.

Featuring workstation-grade performance, system-oriented optimization, versatile expansion features, smart manageability, mobile availability, secure power protection and trusted reliability, Vecow ECX-1400/1300 Series Expandable Fanless Embedded System is your powerful solution for Machine Vision, Intelligent Automation, Smart Manufacturing, Intelligent Surveillance, Vehicle Computing, Robotic Control, Deep Learning and any AIoT or Industry 4.0 embedded applications.

## 1.2 Features

- LGA 1151 Socket supports 8 cores 9th Generation Intel® Xeon®/Core™ i7/i5/i3 Processor (Coffee Lake Refresh) with workstation-grade Intel® C246 Chipset
- Fanless, -40°C to 75°C Operating Temperature
- 2 DDR4 2666MHz Memory, up to 64GB (ECC/Non-ECC)
- 6 GigE LAN with 4 IEEE 802.3at PoE<sup>+</sup>, iAMT 12.0 supported
- Multiple external USB 3.1 Gen 2, up to 10Gbps data transfer
- Expansion : 2 PCI/PCIe, 2 Mini PCIe/mSATA, 1 M.2
- PCIe x16 expansion supports up to 200W Power Budget
- 32 Isolated DIO, 6 USB 3.1, 4 COM RS-232/422/485
- 3 External SIM Card sockets support WiFi/4G/3G/LTE/GPRS/UMTS
- Storage : 4 Front-access 2.5" HDD/SSD Tray, 1 Front-access CFAST Socket, 1 M.2 Socket
- 4 SATA III support RAID 0, 1, 5, 10 data protection
- VGA, DVI-D and dual DisplayPort display interface, up to 4K display
- NVIDIA® GeForce® GTX 1070/GTX 1050 graphics engine, NVIDIA® Pascal™ GPU architecture, up to 8K resolution (ECX-1400/1300 GTX Series)
- 1 VGA, 1 HDMI, 2 DVI and 5 DisplayPort display interfaces, up to 7 independent HD displays (ECX-1400/1300 GTX1070)
- 1 VGA, 1 HDMI, 2 DVI and 3 DisplayPort display interfaces, up to 6 independent HD displays (ECX-1400/1300 GTX1050)
- 6V to 36V DC Power Input with 80V Surge Protection
- 12V to 36V DC Power Input with 80V Surge Protection (ECX-1400/1300 GTX Series)
- Configurable Ignition Power Control

## 1.3 Product Specification

### 1.3.1 Specifications of ECX-1420

<b>System</b>	
Processor	8 cores Intel® Xeon®/Core™ i7/i5/i3 Processor (Coffee Lake Refresh)
Chipset	Intel® C246 Chipset
BIOS	AMI
SIO	IT8786E
Memory	<ul style="list-style-type: none"> <li>• DDR4 2666MHz (ECC/Non-ECC)</li> <li>• Up to 64GB</li> <li>• 2 260-pin SO-DIMM Socket</li> </ul>
<b>I/O Interface</b>	
Serial	4 COM RS-232/422/485 (ESD 8KV)
USB	<ul style="list-style-type: none"> <li>• 6 USB 3.1 (External)</li> <li>• 1 USB 2.0 (Internal)</li> </ul>
Isolated DIO	32 Isolated DIO : 16 DI, 16 DO
LED	Power, HDD, Wireless, PoE
SIM Card	3 SIM Card Socket (External)
<b>Expansion</b>	
Mini PCIe	2 Full-size Mini PCIe Socket for PCIe/USB/External SIM Card/ mSATA
PCI/PCIe	<ul style="list-style-type: none"> <li>• 1 PCIe x16 Slot</li> <li>• 1 PCIe x4 Slot</li> </ul>
M.2	1 M.2 Key E Socket
SUMIT A, B	2 SUMIT Slot (Optional)
<b>Graphics</b>	
Graphics Processor	Intel® UHD Graphics 630
Interface	<ul style="list-style-type: none"> <li>• 1 VGA : Up to 1920 x 1200 @60Hz</li> <li>• 1 DVI-D : Up to 1920 x 1200 @60Hz</li> <li>• 2 DisplayPort : Up to 4096 x 2304 @60Hz</li> </ul>
<b>Storage</b>	
SATA	4 SATA III (6Gbps) support S/W RAID 0, 1, 5 10
mSATA	2 SATA III (Mini PCIe Type, 6Gbps)
M.2	1 M.2 Key B Socket
Storage Device	<ul style="list-style-type: none"> <li>• 1 CFast Socket, Push-in/Push-out Ejector</li> <li>• 4 Front-access 2.5" SSD/HDD Tray</li> </ul>
<b>Audio</b>	
Audio Codec	Realtek ALC888S-VD, 7.1 Channel HD Audio
Audio Interface	1 Mic-in, 1 Line-out
<b>Ethernet</b>	
LAN 1	Intel® I219LM GigE LAN supports iAMT 12.0
LAN 2	Intel® I210 GigE LAN

<b>PoE</b>	
LAN 3	GigE IEEE 802.3at (25.5W/48V) PoE <sup>+</sup> by Intel <sup>®</sup> I350
LAN 4	GigE IEEE 802.3at (25.5W/48V) PoE <sup>+</sup> by Intel <sup>®</sup> I350
LAN 5	GigE IEEE 802.3at (25.5W/48V) PoE <sup>+</sup> by Intel <sup>®</sup> I350
LAN 6	GigE IEEE 802.3at (25.5W/48V) PoE <sup>+</sup> by Intel <sup>®</sup> I350
<b>Power</b>	
Input Voltage	6V to 36V, DC-in
Power Interface	3-pin Terminal Block : V+, V-, Frame Ground
Ignition Control	16 Mode (Internal)
Remote Switch	3-pin Terminal Block : On, Off, IGN
Surge Protection	Up to 80V/1ms Transient Power
<b>Others</b>	
TPM	Optional Infineon SLB9665 supports TPM 2.0, LPC interface
Watchdog Timer	Reset : 1 to 255 sec./min. per step
Smart Management	Wake on LAN, PXE supported
HW Monitor	Monitoring temperature, voltages. Auto throttling control when CPU overheats.
<b>Software Support</b>	
OS	Windows 10, Linux
<b>Mechanical</b>	
Dimension	260mm x 215mm x 104.1mm (10.2" x 8.5" x 4.1")
Weight	5.5 kg (12.13 lb)
Mounting	<ul style="list-style-type: none"> <li>• Wallmount by mounting bracket</li> <li>• DIN Rail Mount (Optional)</li> </ul>
<b>Environment</b>	
Operating Temperature	<b>35W TDP CPU</b> : -40°C to 75°C (-40°F to 167°F) <b>65W TDP CPU</b> : -40°C to 55°C (-40°F to 131°F) <b>80W TDP CPU</b> : -40°C to 45°C (-40°F to 113°F)
Storage Temperature	-40°C to 85°C (-40°F to 185°F)
Humidity	5% to 95% humidity, non-condensing
Relative Humidity	95% at 75°C
Shock	<ul style="list-style-type: none"> <li>• IEC 60068-2-27</li> <li>• SSD : 50G @wallmount, Half-sine, 11ms</li> </ul>
Vibration	<ul style="list-style-type: none"> <li>• IEC 60068-2-64</li> <li>• SSD : 5Grms, 5Hz to 500Hz, 3 Axis</li> </ul>
EMC	CE, FCC, EN50155, EN50121-3-2

### 1.3.2 Specifications of ECX-1411

<b>System</b>	
Processor	8 cores Intel® Xeon®/Core™ i7/i5/i3 Processor (Coffee Lake Refresh)
Chipset	Intel® C246 Chipset
BIOS	AMI
SIO	IT8786E
Memory	<ul style="list-style-type: none"> <li>• DDR4 2666MHz (ECC/Non-ECC)</li> <li>• Up to 64GB</li> <li>• 2 260-pin SO-DIMM Socket</li> </ul>
<b>I/O Interface</b>	
Serial	4 COM RS-232/422/485 (ESD 8KV)
USB	<ul style="list-style-type: none"> <li>• 6 USB 3.1 (External)</li> <li>• 1 USB 2.0 (Internal)</li> </ul>
Isolated DIO	32 Isolated DIO : 16 DI, 16 DO
LED	Power, HDD, Wireless, PoE
SIM Card	3 SIM Card Socket (External)
<b>Expansion</b>	
Mini PCIe	2 Full-size Mini PCIe Socket for PCIe/USB/External SIM Card/mSATA
PCI/PCIe	<ul style="list-style-type: none"> <li>• 1 PCIe x16 Slot</li> <li>• 1 PCI Slot</li> </ul>
M.2	1 M.2 Key E Socket
SUMIT A, B	2 SUMIT Slot (Optional)
<b>Graphics</b>	
Graphics Processor	Intel® UHD Graphics 630
Interface	<ul style="list-style-type: none"> <li>• 1 VGA : Up to 1920 x 1200 @60Hz</li> <li>• 1 DVI-D : Up to 1920 x 1200 @60Hz</li> <li>• 2 DisplayPort : Up to 4096 x 2304 @60Hz</li> </ul>
<b>Storage</b>	
SATA	4 SATA III (6Gbps) support S/W RAID 0, 1, 5 10
mSATA	2 SATA III (Mini PCIe Type, 6Gbps)
M.2	1 M.2 Key B Socket
Storage Device	<ul style="list-style-type: none"> <li>• 1 CFast Socket, Push-in/Push-out Ejector</li> <li>• 4 Front-access 2.5" SSD/HDD Tray</li> </ul>
<b>Audio</b>	
Audio Codec	Realtek ALC888S-VD, 7.1 Channel HD Audio
Audio Interface	1 Mic-in, 1 Line-out
<b>Ethernet</b>	
LAN 1	Intel® I219LM GigE LAN supports iAMT 12.0
LAN 2	Intel® I210 GigE LAN

<b>PoE</b>	
LAN 3	GigE IEEE 802.3at (25.5W/48V) PoE <sup>+</sup> by Intel <sup>®</sup> I350
LAN 4	GigE IEEE 802.3at (25.5W/48V) PoE <sup>+</sup> by Intel <sup>®</sup> I350
LAN 5	GigE IEEE 802.3at (25.5W/48V) PoE <sup>+</sup> by Intel <sup>®</sup> I350
LAN 6	GigE IEEE 802.3at (25.5W/48V) PoE <sup>+</sup> by Intel <sup>®</sup> I350
<b>Power</b>	
Input Voltage	6V to 36V, DC-in
Power Interface	3-pin Terminal Block : V+, V-, Frame Ground
Ignition Control	16 Mode (Internal)
Remote Switch	3-pin Terminal Block : On, Off, IGN
Surge Protection	Up to 80V/1ms Transient Power
<b>Others</b>	
TPM	Optional Infineon SLB9665 supports TPM 2.0, LPC interface
Watchdog Timer	Reset : 1 to 255 sec./min. per step
Smart Management	Wake on LAN, PXE supported
HW Monitor	Monitoring temperature, voltages. Auto throttling control when CPU overheats.
<b>Software Support</b>	
OS	Windows 10, Linux
<b>Mechanical</b>	
Dimension	260mm x 215mm x 104.1mm (10.2" x 8.5" x 4.1")
Weight	5.5 kg (12.13 lb)
Mounting	<ul style="list-style-type: none"> <li>• Wallmount by mounting bracket</li> <li>• DIN Rail Mount (Optional)</li> </ul>
<b>Environment</b>	
Operating Temperature	<b>35W TDP CPU</b> : -40°C to 75°C (-40°F to 167°F) <b>65W TDP CPU</b> : -40°C to 55°C (-40°F to 131°F) <b>80W TDP CPU</b> : -40°C to 45°C (-40°F to 113°F)
Storage Temperature	-40°C to 85°C (-40°F to 185°F)
Humidity	5% to 95% humidity, non-condensing
Relative Humidity	95% at 75°C
Shock	<ul style="list-style-type: none"> <li>• IEC 60068-2-27</li> <li>• SSD : 50G @wallmount, Half-sine, 11ms</li> </ul>
Vibration	<ul style="list-style-type: none"> <li>• IEC 60068-2-64</li> <li>• SSD : 5Grms, 5Hz to 500Hz, 3 Axis</li> </ul>
EMC	CE, FCC, EN50155, EN50121-3-2

### 1.3.3 Specifications of ECX-1402

<b>System</b>	
Processor	8 cores Intel® Xeon®/Core™ i7/i5/i3 Processor (Coffee Lake Refresh)
Chipset	Intel® C246 Chipset
BIOS	AMI
SIO	IT8786E
Memory	<ul style="list-style-type: none"> <li>• DDR4 2666MHz (ECC/Non-ECC)</li> <li>• Up to 64GB</li> <li>• 2 260-pin SO-DIMM Socket</li> </ul>
<b>I/O Interface</b>	
Serial	4 COM RS-232/422/485 (ESD 8KV)
USB	<ul style="list-style-type: none"> <li>• 6 USB 3.1 (External)</li> <li>• 1 USB 2.0 (Internal)</li> </ul>
Isolated DIO	32 Isolated DIO : 16 DI, 16 DO
LED	Power, HDD, Wireless, PoE
SIM Card	3 SIM Card Socket (External)
<b>Expansion</b>	
Mini PCIe	2 Full-size Mini PCIe Socket for PCIe/USB/External SIM Card/mSATA
PCI/PCIe	2 PCI Slot
M.2	1 M.2 Key E Socket
SUMIT A, B	2 SUMIT Slot (Optional)
<b>Graphics</b>	
Graphics Processor	Intel® UHD Graphics 630
Interface	<ul style="list-style-type: none"> <li>• 1 VGA : Up to 1920 x 1200 @60Hz</li> <li>• 1 DVI-D : Up to 1920 x 1200 @60Hz</li> <li>• 2 DisplayPort : Up to 4096 x 2304 @60Hz</li> </ul>
<b>Storage</b>	
SATA	4 SATA III (6Gbps) support S/W RAID 0, 1, 5 10
mSATA	2 SATA III (Mini PCIe Type, 6Gbps)
M.2	1 M.2 Key B Socket
Storage Device	<ul style="list-style-type: none"> <li>• 1 CFast Socket, Push-in/Push-out Ejector</li> <li>• 4 Front-access 2.5" SSD/HDD Tray</li> </ul>
<b>Audio</b>	
Audio Codec	Realtek ALC888S-VD, 7.1 Channel HD Audio
Audio Interface	1 Mic-in, 1 Line-out
<b>Ethernet</b>	
LAN 1	Intel® I219LM GigE LAN supports iAMT 12.0
LAN 2	Intel® I210 GigE LAN

<b>PoE</b>	
LAN 3	GigE IEEE 802.3at (25.5W/48V) PoE <sup>+</sup> by Intel <sup>®</sup> I350
LAN 4	GigE IEEE 802.3at (25.5W/48V) PoE <sup>+</sup> by Intel <sup>®</sup> I350
LAN 5	GigE IEEE 802.3at (25.5W/48V) PoE <sup>+</sup> by Intel <sup>®</sup> I350
LAN 6	GigE IEEE 802.3at (25.5W/48V) PoE <sup>+</sup> by Intel <sup>®</sup> I350
<b>Power</b>	
Input Voltage	6V to 36V, DC-in
Power Interface	3-pin Terminal Block : V+, V-, Frame Ground
Ignition Control	16 Mode (Internal)
Remote Switch	3-pin Terminal Block : On, Off, IGN
Surge Protection	Up to 80V/1ms Transient Power
<b>Others</b>	
TPM	Optional Infineon SLB9665 supports TPM 2.0, LPC interface
Watchdog Timer	Reset : 1 to 255 sec./min. per step
Smart Management	Wake on LAN, PXE supported
HW Monitor	Monitoring temperature, voltages. Auto throttling control when CPU overheats.
<b>Software Support</b>	
OS	Windows 10, Linux
<b>Mechanical</b>	
Dimension	260mm x 215mm x 104.1mm (10.2" x 8.5" x 4.1")
Weight	5.5 kg (12.13 lb)
Mounting	<ul style="list-style-type: none"> <li>• Wallmount by mounting bracket</li> <li>• DIN Rail Mount (Optional)</li> </ul>
<b>Environment</b>	
Operating Temperature	<b>35W TDP CPU</b> : -40°C to 75°C (-40°F to 167°F) <b>65W TDP CPU</b> : -40°C to 55°C (-40°F to 131°F) <b>80W TDP CPU</b> : -40°C to 45°C (-40°F to 113°F)
Storage Temperature	-40°C to 85°C (-40°F to 185°F)
Humidity	5% to 95% humidity, non-condensing
Relative Humidity	95% at 75°C
Shock	<ul style="list-style-type: none"> <li>• IEC 60068-2-27</li> <li>• SSD : 50G @wallmount, Half-sine, 11ms</li> </ul>
Vibration	<ul style="list-style-type: none"> <li>• IEC 60068-2-64</li> <li>• SSD : 5Grms, 5Hz to 500Hz, 3 Axis</li> </ul>
EMC	CE, FCC, EN50155, EN50121-3-2



### 1.3.4 Specifications of ECX-1320

<b>System</b>	
Processor	8 cores Intel® Xeon®/Core™ i7/i5/i3 Processor (Coffee Lake Refresh)
Chipset	Intel® C246 Chipset
BIOS	AMI
SIO	IT8786E
Memory	<ul style="list-style-type: none"> <li>• DDR4 2666MHz (ECC/Non-ECC)</li> <li>• Up to 64GB</li> <li>• 2 260-pin SO-DIMM Socket</li> </ul>
<b>I/O Interface</b>	
Serial	4 COM RS-232/422/485 (ESD 8KV)
USB	<ul style="list-style-type: none"> <li>• 6 USB 3.1 (External)</li> <li>• 1 USB 2.0 (Internal)</li> </ul>
GPIO	16 GPIO
LED	Power, HDD, Wireless
SIM Card	3 SIM Card Socket (External)
<b>Expansion</b>	
Mini PCIe	2 Full-size Mini PCIe Socket for PCIe/USB/External SIM Card/mSATA
PCI/PCIe	<ul style="list-style-type: none"> <li>• 1 PCIe x16 Slot</li> <li>• 1 PCIe x4 Slot</li> </ul>
M.2	1 M.2 Key E Socket
SUMIT A, B	2 SUMIT Slot (Optional)
<b>Graphics</b>	
Graphics Processor	Intel® UHD Graphics 630
Interface	<ul style="list-style-type: none"> <li>• 1 VGA : Up to 1920 x 1200 @60Hz</li> <li>• 1 DVI-D : Up to 1920 x 1200 @60Hz</li> <li>• 2 DisplayPort : Up to 4096 x 2304 @60Hz</li> </ul>
<b>Storage</b>	
SATA	4 SATA III (6Gbps) support S/W RAID 0, 1, 5 10
mSATA	2 SATA III (Mini PCIe Type, 6Gbps)
M.2	1 M.2 Key B Socket
Storage Device	<ul style="list-style-type: none"> <li>• 1 CFast Socket, Push-in/Push-out Ejector</li> <li>• 4 Front-access 2.5" SSD/HDD Tray</li> </ul>
<b>Audio</b>	
Audio Codec	Realtek ALC888S-VD, 7.1 Channel HD Audio
Audio Interface	1 Mic-in, 1 Line-out
<b>Ethernet</b>	
LAN 1	Intel® I219LM GigE LAN supports iAMT 12.0
LAN 2	Intel® I210 GigE LAN

<b>Power</b>	
Input Voltage	6V to 36V, DC-in
Power Interface	3-pin Terminal Block : V+, V-, Frame Ground
Ignition Control	16 Mode (Internal)
Remote Switch	3-pin Terminal Block : On, Off, IGN
Surge Protection	Up to 80V/1ms Transient Power
<b>Others</b>	
TPM	Optional Infineon SLB9665 supports TPM 2.0, LPC interface
Watchdog Timer	Reset : 1 to 255 sec./min. per step
Smart Management	Wake on LAN, PXE supported
HW Monitor	Monitoring temperature, voltages. Auto throttling control when CPU overheats.
<b>Software Support</b>	
OS	Windows 10, Linux
<b>Mechanical</b>	
Dimension	260mm x 215mm x 104.1mm (10.2" x 8.5" x 4.1")
Weight	5.5 kg (12.13 lb)
Mounting	<ul style="list-style-type: none"> <li>• Wallmount by mounting bracket</li> <li>• DIN Rail Mount (Optional)</li> </ul>
<b>Environment</b>	
Operating Temperature	<b>35W TDP CPU</b> : -40°C to 75°C (-40°F to 167°F) <b>65W TDP CPU</b> : -40°C to 55°C (-40°F to 131°F) <b>80W TDP CPU</b> : -40°C to 45°C (-40°F to 113°F)
Storage Temperature	-40°C to 85°C (-40°F to 185°F)
Humidity	5% to 95% humidity, non-condensing
Relative Humidity	95% at 75°C
Shock	<ul style="list-style-type: none"> <li>• IEC 60068-2-27</li> <li>• SSD : 50G @wallmount, Half-sine, 11ms</li> </ul>
Vibration	<ul style="list-style-type: none"> <li>• IEC 60068-2-64</li> <li>• SSD : 5Grms, 5Hz to 500Hz, 3 Axis</li> </ul>
EMC	CE, FCC, EN50155, EN50121-3-2

### 1.3.5 Specifications of ECX-1311

<b>System</b>	
Processor	8 cores Intel® Xeon®/Core™ i7/i5/i3 Processor (Coffee Lake Refresh)
Chipset	Intel® C246 Chipset
BIOS	AMI
SIO	IT8786E
Memory	<ul style="list-style-type: none"> <li>• DDR4 2666MHz (ECC/Non-ECC)</li> <li>• Up to 64GB</li> <li>• 2 260-pin SO-DIMM Socket</li> </ul>
<b>I/O Interface</b>	
Serial	4 COM RS-232/422/485 (ESD 8KV)
USB	<ul style="list-style-type: none"> <li>• 6 USB 3.1 (External)</li> <li>• 1 USB 2.0 (Internal)</li> </ul>
GPIO	16 GPIO
LED	Power, HDD, Wireless
SIM Card	3 SIM Card Socket (External)
<b>Expansion</b>	
Mini PCIe	2 Full-size Mini PCIe Socket for PCIe/USB/External SIM Card/mSATA
PCI/PCIe	<ul style="list-style-type: none"> <li>• 1 PCIe x16 Slot</li> <li>• 1 PCI Slot</li> </ul>
M.2	1 M.2 Key E Socket
SUMIT A, B	2 SUMIT Slot (Optional)
<b>Graphics</b>	
Graphics Processor	Intel® UHD Graphics 630
Interface	<ul style="list-style-type: none"> <li>• 1 VGA : Up to 1920 x 1200 @60Hz</li> <li>• 1 DVI-D : Up to 1920 x 1200 @60Hz</li> <li>• 2 DisplayPort : Up to 4096 x 2304 @60Hz</li> </ul>
<b>Storage</b>	
SATA	4 SATA III (6Gbps) support S/W RAID 0, 1, 5 10
mSATA	2 SATA III (Mini PCIe Type, 6Gbps)
M.2	1 M.2 Key B Socket
Storage Device	<ul style="list-style-type: none"> <li>• 1 CFast Socket, Push-in/Push-out Ejector</li> <li>• 4 Front-access 2.5" SSD/HDD Tray</li> </ul>
<b>Audio</b>	
Audio Codec	Realtek ALC888S-VD, 7.1 Channel HD Audio
Audio Interface	1 Mic-in, 1 Line-out
<b>Ethernet</b>	
LAN 1	Intel® I219LM GigE LAN supports iAMT 12.0
LAN 2	Intel® I210 GigE LAN

<b>Power</b>	
Input Voltage	6V to 36V, DC-in
Power Interface	3-pin Terminal Block : V+, V-, Frame Ground
Ignition Control	16 Mode (Internal)
Remote Switch	3-pin Terminal Block : On, Off, IGN
Surge Protection	Up to 80V/1ms Transient Power
<b>Others</b>	
TPM	Optional Infineon SLB9665 supports TPM 2.0, LPC interface
Watchdog Timer	Reset : 1 to 255 sec./min. per step
Smart Management	Wake on LAN, PXE supported
HW Monitor	Monitoring temperature, voltages. Auto throttling control when CPU overheats.
<b>Software Support</b>	
OS	Windows 10, Linux
<b>Mechanical</b>	
Dimension	260mm x 215mm x 104.1mm (10.2" x 8.5" x 4.1")
Weight	5.5 kg (12.13 lb)
Mounting	<ul style="list-style-type: none"> <li>• Wallmount by mounting bracket</li> <li>• DIN Rail Mount (Optional)</li> </ul>
<b>Environment</b>	
Operating Temperature	<b>35W TDP CPU</b> : -40°C to 75°C (-40°F to 167°F) <b>65W TDP CPU</b> : -40°C to 55°C (-40°F to 131°F) <b>80W TDP CPU</b> : -40°C to 45°C (-40°F to 113°F)
Storage Temperature	-40°C to 85°C (-40°F to 185°F)
Humidity	5% to 95% humidity, non-condensing
Relative Humidity	95% at 75°C
Shock	<ul style="list-style-type: none"> <li>• IEC 60068-2-27</li> <li>• SSD : 50G @wallmount, Half-sine, 11ms</li> </ul>
Vibration	<ul style="list-style-type: none"> <li>• IEC 60068-2-64</li> <li>• SSD : 5Grms, 5Hz to 500Hz, 3 Axis</li> </ul>
EMC	CE, FCC, EN50155, EN50121-3-2

### 1.3.6 Specifications of ECX-1302

<b>System</b>	
Processor	8 cores Intel® Xeon®/Core™ i7/i5/i3 Processor (Coffee Lake Refresh)
Chipset	Intel® C246 Chipset
BIOS	AMI
SIO	IT8786E
Memory	<ul style="list-style-type: none"> <li>• DDR4 2666MHz (ECC/Non-ECC)</li> <li>• Up to 64GB</li> <li>• 2 260-pin SO-DIMM Socket</li> </ul>
<b>I/O Interface</b>	
Serial	4 COM RS-232/422/485 (ESD 8KV)
USB	<ul style="list-style-type: none"> <li>• 6 USB 3.1 (External)</li> <li>• 1 USB 2.0 (Internal)</li> </ul>
GPIO	16 GPIO
LED	Power, HDD, Wireless
SIM Card	3 SIM Card Socket (External)
<b>Expansion</b>	
Mini PCIe	2 Full-size Mini PCIe Socket for PCIe/USB/External SIM Card/mSATA
PCI/PCIe	2 PCI Slot
M.2	1 M.2 Key E Socket
SUMIT A, B	2 SUMIT Slot (Optional)
<b>Graphics</b>	
Graphics Processor	Intel® UHD Graphics 630
Interface	<ul style="list-style-type: none"> <li>• 1 VGA : Up to 1920 x 1200 @60Hz</li> <li>• 1 DVI-D : Up to 1920 x 1200 @60Hz</li> <li>• 2 DisplayPort : Up to 4096 x 2304 @60Hz</li> </ul>
<b>Storage</b>	
SATA	4 SATA III (6Gbps) support S/W RAID 0, 1, 5 10
mSATA	2 SATA III (Mini PCIe Type, 6Gbps)
M.2	1 M.2 Key B Socket
Storage Device	<ul style="list-style-type: none"> <li>• 1 CFAST Socket, Push-in/Push-out Ejector</li> <li>• 4 Front-access 2.5" SSD/HDD Tray</li> </ul>
<b>Audio</b>	
Audio Codec	Realtek ALC888S-VD, 7.1 Channel HD Audio
Audio Interface	1 Mic-in, 1 Line-out
<b>Ethernet</b>	
LAN 1	Intel® I219LM GigE LAN supports iAMT 12.0
LAN 2	Intel® I210 GigE LAN

<b>Power</b>	
Input Voltage	6V to 36V, DC-in
Power Interface	3-pin Terminal Block : V+, V-, Frame Ground
Ignition Control	16 Mode (Internal)
Remote Switch	3-pin Terminal Block : On, Off, IGN
Surge Protection	Up to 80V/1ms Transient Power
<b>Others</b>	
TPM	Optional Infineon SLB9665 supports TPM 2.0, LPC interface
Watchdog Timer	Reset : 1 to 255 sec./min. per step
Smart Management	Wake on LAN, PXE supported
HW Monitor	Monitoring temperature, voltages. Auto throttling control when CPU overheats.
<b>Software Support</b>	
OS	Windows 10, Linux
<b>Mechanical</b>	
Dimension	260mm x 215mm x 104.1mm (10.2" x 8.5" x 4.1")
Weight	5.5 kg (12.13 lb)
Mounting	<ul style="list-style-type: none"> <li>• Wallmount by mounting bracket</li> <li>• DIN Rail Mount (Optional)</li> </ul>
<b>Environment</b>	
Operating Temperature	<b>35W TDP CPU</b> : -40°C to 75°C (-40°F to 167°F) <b>65W TDP CPU</b> : -40°C to 55°C (-40°F to 131°F) <b>80W TDP CPU</b> : -40°C to 45°C (-40°F to 113°F)
Storage Temperature	-40°C to 85°C (-40°F to 185°F)
Humidity	5% to 95% humidity, non-condensing
Relative Humidity	95% at 75°C
Shock	<ul style="list-style-type: none"> <li>• IEC 60068-2-27</li> <li>• SSD : 50G @wallmount, Half-sine, 11ms</li> </ul>
Vibration	<ul style="list-style-type: none"> <li>• IEC 60068-2-64</li> <li>• SSD : 5Grms, 5Hz to 500Hz, 3 Axis</li> </ul>
EMC	CE, FCC, EN50155, EN50121-3-2

### 1.3.7 Specifications of ECX-1400 GTX1070

<b>System</b>	
Processor	8 cores Intel® Xeon®/Core™ i7/i5/i3 Processor (Coffee Lake Refresh)
Chipset	Intel® C246 Chipset
BIOS	AMI
SIO	IT8786E
Memory	<ul style="list-style-type: none"> <li>• DDR4 2666MHz (ECC/Non-ECC)</li> <li>• Up to 64GB</li> <li>• 2 260-pin SO-DIMM Socket</li> </ul>
<b>I/O Interface</b>	
Serial	4 COM RS-232/422/485 (ESD 8KV)
USB	<ul style="list-style-type: none"> <li>• 6 USB 3.1 (External)</li> <li>• 1 USB 2.0 (Internal)</li> </ul>
Isolated DIO	32 Isolated DIO : 16 DI, 16 DO
LED	Power, HDD, Wireless, PoE
SIM Card	3 SIM Card Socket (External)
<b>Expansion</b>	
Mini PCIe	2 Full-size Mini PCIe Socket for PCIe/USB/External SIM Card/mSATA
M.2	1 M.2 Key E Socket
<b>Graphics</b>	
Graphics Processor	<ul style="list-style-type: none"> <li>• Intel® UHD Graphics 630</li> <li>• NVIDIA® GeForce® GTX 1070</li> </ul>
Interface	<ul style="list-style-type: none"> <li>• 1 VGA : Up to 1920 x 1200 @60Hz</li> <li>• 1 HDMI : Up to 4096 x 2304 @60Hz</li> <li>• 2 DVI-D : Up to 1920 x 1200 @60Hz</li> <li>• 3 DisplayPort : Up to 7680 x 3840 @60Hz</li> <li>• 2 DisplayPort : Up to 4096 x 2304 @60Hz</li> </ul>
<b>Storage</b>	
SATA	4 SATA III (6Gbps) support S/W RAID 0, 1, 5 10
mSATA	2 SATA III (Mini PCIe Type, 6Gbps)
M.2	1 M.2 Key B Socket
Storage Device	<ul style="list-style-type: none"> <li>• 1 CFAST Socket, Push-in/Push-out Ejector</li> <li>• 4 Front-access 2.5" SSD/HDD Tray</li> </ul>
<b>Audio</b>	
Audio Codec	Realtek ALC888S-VD, 7.1 Channel HD Audio
Audio Interface	1 Mic-in, 1 Line-out
<b>Ethernet</b>	
LAN 1	Intel® I219LM GigE LAN supports iAMT 12.0
LAN 2	Intel® I210 GigE LAN

<b>PoE</b>	
LAN 3	GigE IEEE 802.3at (25.5W/48V) PoE <sup>+</sup> by Intel <sup>®</sup> I350
LAN 4	GigE IEEE 802.3at (25.5W/48V) PoE <sup>+</sup> by Intel <sup>®</sup> I350
LAN 5	GigE IEEE 802.3at (25.5W/48V) PoE <sup>+</sup> by Intel <sup>®</sup> I350
LAN 6	GigE IEEE 802.3at (25.5W/48V) PoE <sup>+</sup> by Intel <sup>®</sup> I350
<b>Power</b>	
Input Voltage	12V to 36V, DC-in
Power Interface	3-pin Terminal Block : V+, V-, Frame Ground
Ignition Control	16 Mode (Internal)
Remote Switch	3-pin Terminal Block : On, Off, IGN
Surge Protection	Up to 80V/1ms Transient Power
<b>Others</b>	
TPM	Optional Infineon SLB9665 supports TPM 2.0, LPC interface
Watchdog Timer	Reset : 1 to 255 sec./min. per step
Smart Management	Wake on LAN, PXE supported
HW Monitor	Monitoring temperature, voltages. Auto throttling control when CPU overheats.
<b>Software Support</b>	
OS	Windows 10, Linux
<b>Mechanical</b>	
Dimension	260mm x 215mm x 104.1mm (10.2" x 8.5" x 4.1")
Weight	5.8 kg (12.79 lb)
Mounting	<ul style="list-style-type: none"> <li>• Wallmount by mounting bracket</li> <li>• DIN Rail Mount (Optional)</li> </ul>
<b>Environment</b>	
Operating Temperature	<b>35W TDP CPU</b> : -20°C to 60°C (-4°F to 140°F) <b>65W TDP CPU</b> : -20°C to 55°C (-4°F to 131°F) <b>80W TDP CPU</b> : -20°C to 45°C (-4°F to 113°F)
Storage Temperature	-40°C to 85°C (-40°F to 185°F)
Humidity	5% to 95% humidity, non-condensing
Relative Humidity	95% at 60°C
Shock	<ul style="list-style-type: none"> <li>• IEC 60068-2-27</li> <li>• SSD : 50G @wallmount, Half-sine, 11ms</li> </ul>
Vibration	<ul style="list-style-type: none"> <li>• IEC 60068-2-64</li> <li>• SSD : 5Grms, 5Hz to 500Hz, 3 Axis</li> </ul>
EMC	CE, FCC, EN50155, EN50121-3-2



### 1.3.8 Specifications of ECX-1300 GTX1070

<b>System</b>	
Processor	8 cores Intel® Xeon®/Core™ i7/i5/i3 Processor (Coffee Lake Refresh)
Chipset	Intel® C246 Chipset
BIOS	AMI
SIO	IT8786E
Memory	<ul style="list-style-type: none"> <li>• DDR4 2666MHz (ECC/Non-ECC)</li> <li>• Up to 64GB</li> <li>• 2 260-pin SO-DIMM Socket</li> </ul>
<b>I/O Interface</b>	
Serial	4 COM RS-232/422/485 (ESD 8KV)
USB	<ul style="list-style-type: none"> <li>• 6 USB 3.1 (External)</li> <li>• 1 USB 2.0 (Internal)</li> </ul>
GPIO	16 GPIO
LED	Power, HDD, Wireless
SIM Card	3 SIM Card Socket (External)
<b>Expansion</b>	
Mini PCIe	2 Full-size Mini PCIe Socket for PCIe/USB/External SIM Card/mSATA
M.2	1 M.2 Key E Socket
<b>Graphics</b>	
Graphics Processor	<ul style="list-style-type: none"> <li>• Intel® UHD Graphics 630</li> <li>• NVIDIA® GeForce® GTX 1070</li> </ul>
Interface	<ul style="list-style-type: none"> <li>• 1 VGA : Up to 1920 x 1200 @60Hz</li> <li>• 1 HDMI : Up to 4096 x 2304 @60Hz</li> <li>• 2 DVI-D : Up to 1920 x 1200 @60Hz</li> <li>• 3 DisplayPort : Up to 7680 x 3840 @60Hz</li> <li>• 2 DisplayPort : Up to 4096 x 2304 @60Hz</li> </ul>
<b>Storage</b>	
SATA	4 SATA III (6Gbps) support S/W RAID 0, 1, 5 10
mSATA	2 SATA III (Mini PCIe Type, 6Gbps)
M.2	1 M.2 Key B Socket
Storage Device	<ul style="list-style-type: none"> <li>• 1 CFast Socket, Push-in/Push-out Ejector</li> <li>• 4 Front-access 2.5" SSD/HDD Tray</li> </ul>
<b>Audio</b>	
Audio Codec	Realtek ALC888S-VD, 7.1 Channel HD Audio
Audio Interface	1 Mic-in, 1 Line-out
<b>Ethernet</b>	
LAN 1	Intel® I219LM GigE LAN supports iAMT 12.0
LAN 2	Intel® I210 GigE LAN

<b>Power</b>	
Input Voltage	12V to 36V, DC-in
Power Interface	3-pin Terminal Block : V+, V-, Frame Ground
Ignition Control	16 Mode (Internal)
Remote Switch	3-pin Terminal Block : On, Off, IGN
Surge Protection	Up to 80V/1ms Transient Power
<b>Others</b>	
TPM	Optional Infineon SLB9665 supports TPM 2.0, LPC interface
Watchdog Timer	Reset : 1 to 255 sec./min. per step
Smart Management	Wake on LAN, PXE supported
HW Monitor	Monitoring temperature, voltages. Auto throttling control when CPU overheats.
<b>Software Support</b>	
OS	Windows 10, Linux
<b>Mechanical</b>	
Dimension	260mm x 215mm x 104.1mm (10.2" x 8.5" x 4.1")
Weight	5.8 kg (12.79 lb)
Mounting	<ul style="list-style-type: none"> <li>• Wallmount by mounting bracket</li> <li>• DIN Rail Mount (Optional)</li> </ul>
<b>Environment</b>	
Operating Temperature	<b>35W TDP CPU</b> : -20°C to 60°C (-4°F to 140°F) <b>65W TDP CPU</b> : -20°C to 55°C (-4°F to 131°F) <b>80W TDP CPU</b> : -20°C to 45°C (-4°F to 113°F)
Storage Temperature	-40°C to 85°C (-40°F to 185°F)
Humidity	5% to 95% humidity, non-condensing
Relative Humidity	95% at 60°C
Shock	<ul style="list-style-type: none"> <li>• IEC 60068-2-27</li> <li>• SSD : 50G @wallmount, Half-sine, 11ms</li> </ul>
Vibration	<ul style="list-style-type: none"> <li>• IEC 60068-2-64</li> <li>• SSD : 5Grms, 5Hz to 500Hz, 3 Axis</li> </ul>
EMC	CE, FCC, EN50155, EN50121-3-2

### 1.3.9 Specifications of ECX-1410 GTX1050

<b>System</b>	
Processor	8 cores Intel® Xeon®/Core™ i7/i5/i3 Processor (Coffee Lake Refresh)
Chipset	Intel® C246 Chipset
BIOS	AMI
SIO	IT8786E
Memory	<ul style="list-style-type: none"> <li>• DDR4 2666MHz (ECC/Non-ECC)</li> <li>• Up to 64GB</li> <li>• 2 260-pin SO-DIMM Socket</li> </ul>
<b>I/O Interface</b>	
Serial	4 COM RS-232/422/485 (ESD 8KV)
USB	<ul style="list-style-type: none"> <li>• 6 USB 3.1 (External)</li> <li>• 1 USB 2.0 (Internal)</li> </ul>
Isolated DIO	32 Isolated DIO : 16 DI, 16 DO
LED	Power, HDD, Wireless, PoE
SIM Card	3 SIM Card Socket (External)
<b>Expansion</b>	
Mini PCIe	2 Full-size Mini PCIe Socket for PCIe/USB/External SIM Card/mSATA
PCI/PCIe	1 PCIe x4 Slot
M.2	1 M.2 Key E Socket
<b>Graphics</b>	
Graphics Processor	<ul style="list-style-type: none"> <li>• Intel® UHD Graphics 630</li> <li>• NVIDIA® GeForce® GTX 1050 Ti/GTX 1050</li> </ul>
Interface	<ul style="list-style-type: none"> <li>• 1 VGA : Up to 1920 x 1200 @60Hz</li> <li>• 1 HDMI : Up to 4096 x 2304 @60Hz</li> <li>• 2 DVI-D : Up to 1920 x 1200 @60Hz</li> <li>• 1 DisplayPort : Up to 7680 x 3840 @60Hz</li> <li>• 2 DisplayPort : Up to 4096 x 2304 @60Hz</li> </ul>
<b>Storage</b>	
SATA	4 SATA III (6Gbps) support S/W RAID 0, 1, 5 10
mSATA	2 SATA III (Mini PCIe Type, 6Gbps)
M.2	1 M.2 Key B Socket
Storage Device	<ul style="list-style-type: none"> <li>• 1 CFAST Socket, Push-in/Push-out Ejector</li> <li>• 4 Front-access 2.5" SSD/HDD Tray</li> </ul>
<b>Audio</b>	
Audio Codec	Realtek ALC888S-VD, 7.1 Channel HD Audio
Audio Interface	1 Mic-in, 1 Line-out
<b>Ethernet</b>	
LAN 1	Intel® I219LM GigE LAN supports iAMT 12.0
LAN 2	Intel® I210 GigE LAN

<b>PoE</b>	
LAN 3	GigE IEEE 802.3at (25.5W/48V) PoE <sup>+</sup> by Intel <sup>®</sup> I350
LAN 4	GigE IEEE 802.3at (25.5W/48V) PoE <sup>+</sup> by Intel <sup>®</sup> I350
LAN 5	GigE IEEE 802.3at (25.5W/48V) PoE <sup>+</sup> by Intel <sup>®</sup> I350
LAN 6	GigE IEEE 802.3at (25.5W/48V) PoE <sup>+</sup> by Intel <sup>®</sup> I350
<b>Power</b>	
Input Voltage	12V to 36V, DC-in
Power Interface	3-pin Terminal Block : V+, V-, Frame Ground
Ignition Control	16 Mode (Internal)
Remote Switch	3-pin Terminal Block : On, Off, IGN
Surge Protection	Up to 80V/1ms Transient Power
<b>Others</b>	
TPM	Optional Infineon SLB9665 supports TPM 2.0, LPC interface
Watchdog Timer	Reset : 1 to 255 sec./min. per step
Smart Management	Wake on LAN, PXE supported
HW Monitor	Monitoring temperature, voltages. Auto throttling control when CPU overheats.
<b>Software Support</b>	
OS	Windows 10, Linux
<b>Mechanical</b>	
Dimension	260mm x 215mm x 104.1mm (10.2" x 8.5" x 4.1")
Weight	5.8 kg (12.79 lb)
Mounting	<ul style="list-style-type: none"> <li>• Wallmount by mounting bracket</li> <li>• DIN Rail Mount (Optional)</li> </ul>
<b>Environment</b>	
Operating Temperature	<b>35W TDP CPU</b> : -20°C to 60°C (-4°F to 140°F) <b>65W TDP CPU</b> : -20°C to 55°C (-4°F to 131°F) <b>80W TDP CPU</b> : -20°C to 45°C (-4°F to 113°F)
Storage Temperature	-40°C to 85°C (-40°F to 185°F)
Humidity	5% to 95% humidity, non-condensing
Relative Humidity	95% at 60°C
Shock	<ul style="list-style-type: none"> <li>• IEC 60068-2-27</li> <li>• SSD : 50G @wallmount, Half-sine, 11ms</li> </ul>
Vibration	<ul style="list-style-type: none"> <li>• IEC 60068-2-64</li> <li>• SSD : 5Grms, 5Hz to 500Hz, 3 Axis</li> </ul>
EMC	CE, FCC, EN50155, EN50121-3-2

### 1.3.10 Specifications of ECX-1401 GTX1050

<b>System</b>	
Processor	8 cores Intel® Xeon®/Core™ i7/i5/i3 Processor (Coffee Lake Refresh)
Chipset	Intel® C246 Chipset
BIOS	AMI
SIO	IT8786E
Memory	<ul style="list-style-type: none"> <li>• DDR4 2666MHz (ECC/Non-ECC)</li> <li>• Up to 64GB</li> <li>• 2 260-pin SO-DIMM Socket</li> </ul>
<b>I/O Interface</b>	
Serial	4 COM RS-232/422/485 (ESD 8KV)
USB	<ul style="list-style-type: none"> <li>• 6 USB 3.1 (External)</li> <li>• 1 USB 2.0 (Internal)</li> </ul>
Isolated DIO	32 Isolated DIO : 16 DI, 16 DO
LED	Power, HDD, Wireless, PoE
SIM Card	3 SIM Card Socket (External)
<b>Expansion</b>	
Mini PCIe	2 Full-size Mini PCIe Socket for PCIe/USB/External SIM Card/mSATA
PCI/PCIe	1 PCI Slot
M.2	1 M.2 Key E Socket
<b>Graphics</b>	
Graphics Processor	<ul style="list-style-type: none"> <li>• Intel® UHD Graphics 630</li> <li>• NVIDIA® GeForce® GTX 1050 Ti/GTX 1050</li> </ul>
Interface	<ul style="list-style-type: none"> <li>• 1 VGA : Up to 1920 x 1200 @60Hz</li> <li>• 1 HDMI : Up to 4096 x 2304 @60Hz</li> <li>• 2 DVI-D : Up to 1920 x 1200 @60Hz</li> <li>• 1 DisplayPort : Up to 7680 x 3840 @60Hz</li> <li>• 2 DisplayPort : Up to 4096 x 2304 @60Hz</li> </ul>
<b>Storage</b>	
SATA	4 SATA III (6Gbps) support S/W RAID 0, 1, 5 10
mSATA	2 SATA III (Mini PCIe Type, 6Gbps)
M.2	1 M.2 Key B Socket
Storage Device	<ul style="list-style-type: none"> <li>• 1 CFast Socket, Push-in/Push-out Ejector</li> <li>• 4 Front-access 2.5" SSD/HDD Tray</li> </ul>
<b>Audio</b>	
Audio Codec	Realtek ALC888S-VD, 7.1 Channel HD Audio
Audio Interface	1 Mic-in, 1 Line-out
<b>Ethernet</b>	
LAN 1	Intel® I219LM GigE LAN supports iAMT 12.0
LAN 2	Intel® I210 GigE LAN

<b>PoE</b>	
LAN 3	GigE IEEE 802.3at (25.5W/48V) PoE <sup>+</sup> by Intel <sup>®</sup> I350
LAN 4	GigE IEEE 802.3at (25.5W/48V) PoE <sup>+</sup> by Intel <sup>®</sup> I350
LAN 5	GigE IEEE 802.3at (25.5W/48V) PoE <sup>+</sup> by Intel <sup>®</sup> I350
LAN 6	GigE IEEE 802.3at (25.5W/48V) PoE <sup>+</sup> by Intel <sup>®</sup> I350
<b>Power</b>	
Input Voltage	12V to 36V, DC-in
Power Interface	3-pin Terminal Block : V+, V-, Frame Ground
Ignition Control	16 Mode (Internal)
Remote Switch	3-pin Terminal Block : On, Off, IGN
Surge Protection	Up to 80V/1ms Transient Power
<b>Others</b>	
TPM	Optional Infineon SLB9665 supports TPM 2.0, LPC interface
Watchdog Timer	Reset : 1 to 255 sec./min. per step
Smart Management	Wake on LAN, PXE supported
HW Monitor	Monitoring temperature, voltages. Auto throttling control when CPU overheats.
<b>Software Support</b>	
OS	Windows 10, Linux
<b>Mechanical</b>	
Dimension	260mm x 215mm x 104.1mm (10.2" x 8.5" x 4.1")
Weight	5.8 kg (12.79 lb)
Mounting	<ul style="list-style-type: none"> <li>• Wallmount by mounting bracket</li> <li>• DIN Rail Mount (Optional)</li> </ul>
<b>Environment</b>	
Operating Temperature	<b>35W TDP CPU</b> : -20°C to 60°C (-4°F to 140°F) <b>65W TDP CPU</b> : -20°C to 55°C (-4°F to 131°F) <b>80W TDP CPU</b> : -20°C to 45°C (-4°F to 113°F)
Storage Temperature	-40°C to 85°C (-40°F to 185°F)
Humidity	5% to 95% humidity, non-condensing
Relative Humidity	95% at 60°C
Shock	<ul style="list-style-type: none"> <li>• IEC 60068-2-27</li> <li>• SSD : 50G @wallmount, Half-sine, 11ms</li> </ul>
Vibration	<ul style="list-style-type: none"> <li>• IEC 60068-2-64</li> <li>• SSD : 5Grms, 5Hz to 500Hz, 3 Axis</li> </ul>
EMC	CE, FCC, EN50155, EN50121-3-2

### 1.3.11 Specifications of ECX-1310 GTX1050

<b>System</b>	
Processor	8 cores Intel® Xeon®/Core™ i7/i5/i3 Processor (Coffee Lake Refresh)
Chipset	Intel® C246 Chipset
BIOS	AMI
SIO	IT8786E
Memory	<ul style="list-style-type: none"> <li>• DDR4 2666MHz (ECC/Non-ECC)</li> <li>• Up to 64GB</li> <li>• 2 260-pin SO-DIMM Socket</li> </ul>
<b>I/O Interface</b>	
Serial	4 COM RS-232/422/485 (ESD 8KV)
USB	<ul style="list-style-type: none"> <li>• 6 USB 3.1 (External)</li> <li>• 1 USB 2.0 (Internal)</li> </ul>
GPIO	16 GPIO
LED	Power, HDD, Wireless
SIM Card	3 SIM Card Socket (External)
<b>Expansion</b>	
Mini PCIe	2 Full-size Mini PCIe Socket for PCIe/USB/External SIM Card/mSATA
PCI/PCIe	1 PCIe x4 Slot
M.2	1 M.2 Key E Socket
<b>Graphics</b>	
Graphics Processor	<ul style="list-style-type: none"> <li>• Intel® UHD Graphics 630</li> <li>• NVIDIA® GeForce® GTX 1050 Ti/GTX 1050</li> </ul>
Interface	<ul style="list-style-type: none"> <li>• 1 VGA : Up to 1920 x 1200 @60Hz</li> <li>• 1 HDMI : Up to 4096 x 2304 @60Hz</li> <li>• 2 DVI-D : Up to 1920 x 1200 @60Hz</li> <li>• 1 DisplayPort : Up to 7680 x 3840 @60Hz</li> <li>• 2 DisplayPort : Up to 4096 x 2304 @60Hz</li> </ul>
<b>Storage</b>	
SATA	4 SATA III (6Gbps) support S/W RAID 0, 1, 5 10
mSATA	2 SATA III (Mini PCIe Type, 6Gbps)
M.2	1 M.2 Key B Socket
Storage Device	<ul style="list-style-type: none"> <li>• 1 CFast Socket, Push-in/Push-out Ejector</li> <li>• 4 Front-access 2.5" SSD/HDD Tray</li> </ul>
<b>Audio</b>	
Audio Codec	Realtek ALC888S-VD, 7.1 Channel HD Audio
Audio Interface	1 Mic-in, 1 Line-out
<b>Ethernet</b>	
LAN 1	Intel® I219LM GigE LAN supports iAMT 12.0
LAN 2	Intel® I210 GigE LAN

<b>Power</b>	
Input Voltage	12V to 36V, DC-in
Power Interface	<ul style="list-style-type: none"> <li>• 3-pin Terminal Block : V+, V-, Frame Ground</li> <li>• Mini-DIN 4-pin</li> </ul>
Ignition Control	16 Mode (Internal)
Remote Switch	3-pin Terminal Block : On, Off, IGN
Surge Protection	Up to 80V/1ms Transient Power
<b>Others</b>	
TPM	Optional Infineon SLB9665 supports TPM 2.0, LPC interface
Watchdog Timer	Reset : 1 to 255 sec./min. per step
Smart Management	Wake on LAN, PXE supported
HW Monitor	Monitoring temperature, voltages. Auto throttling control when CPU overheats.
<b>Software Support</b>	
OS	Windows 10, Linux
<b>Mechanical</b>	
Dimension	260mm x 215mm x 104.1mm (10.2" x 8.5" x 4.1")
Weight	5.8 kg (12.79 lb)
Mounting	<ul style="list-style-type: none"> <li>• Wallmount by mounting bracket</li> <li>• DIN Rail Mount (Optional)</li> </ul>
<b>Environment</b>	
Operating Temperature	<b>35W TDP CPU</b> : -20°C to 60°C (-4°F to 140°F) <b>65W TDP CPU</b> : -20°C to 55°C (-4°F to 131°F) <b>80W TDP CPU</b> : -20°C to 45°C (-4°F to 113°F)
Storage Temperature	-40°C to 85°C (-40°F to 185°F)
Humidity	5% to 95% humidity, non-condensing
Relative Humidity	95% at 60°C
Shock	<ul style="list-style-type: none"> <li>• IEC 60068-2-27</li> <li>• SSD : 50G @wallmount, Half-sine, 11ms</li> </ul>
Vibration	<ul style="list-style-type: none"> <li>• IEC 60068-2-64</li> <li>• SSD : 5Grms, 5Hz to 500Hz, 3 Axis</li> </ul>
EMC	CE, FCC, EN50155, EN50121-3-2



### 1.3.12 Specifications of ECX-1301 GTX1050

<b>System</b>	
Processor	8 cores Intel® Xeon®/Core™ i7/i5/i3 Processor (Coffee Lake Refresh)
Chipset	Intel® C246 Chipset
BIOS	AMI
SIO	IT8786E
Memory	<ul style="list-style-type: none"> <li>• DDR4 2666MHz (ECC/Non-ECC)</li> <li>• Up to 64GB</li> <li>• 2 260-pin SO-DIMM Socket</li> </ul>
<b>I/O Interface</b>	
Serial	4 COM RS-232/422/485 (ESD 8KV)
USB	<ul style="list-style-type: none"> <li>• 6 USB 3.1 (External)</li> <li>• 1 USB 2.0 (Internal)</li> </ul>
GPIO	16 GPIO
LED	Power, HDD, Wireless
SIM Card	3 SIM Card Socket (External)
<b>Expansion</b>	
Mini PCIe	2 Full-size Mini PCIe Socket for PCIe/USB/External SIM Card/mSATA
PCI/PCIe	1 PCI Slot
M.2	1 M.2 Key E Socket
<b>Graphics</b>	
Graphics Processor	<ul style="list-style-type: none"> <li>• Intel® UHD Graphics 630</li> <li>• NVIDIA® GeForce® GTX 1050 Ti/GTX 1050</li> </ul>
Interface	<ul style="list-style-type: none"> <li>• 1 VGA : Up to 1920 x 1200 @60Hz</li> <li>• 1 HDMI : Up to 4096 x 2304 @60Hz</li> <li>• 2 DVI-D : Up to 1920 x 1200 @60Hz</li> <li>• 1 DisplayPort : Up to 7680 x 3840 @60Hz</li> <li>• 2 DisplayPort : Up to 4096 x 2304 @60Hz</li> </ul>
<b>Storage</b>	
SATA	4 SATA III (6Gbps) support S/W RAID 0, 1, 5 10
mSATA	2 SATA III (Mini PCIe Type, 6Gbps)
M.2	1 M.2 Key B Socket
Storage Device	<ul style="list-style-type: none"> <li>• 1 CFast Socket, Push-in/Push-out Ejector</li> <li>• 4 Front-access 2.5" SSD/HDD Tray</li> </ul>
<b>Audio</b>	
Audio Codec	Realtek ALC888S-VD, 7.1 Channel HD Audio
Audio Interface	1 Mic-in, 1 Line-out
<b>Ethernet</b>	
LAN 1	Intel® I219LM GigE LAN supports iAMT 12.0
LAN 2	Intel® I210 GigE LAN

<b>Power</b>	
Input Voltage	12V to 36V, DC-in
Power Interface	3-pin Terminal Block : V+, V-, Frame Ground
Ignition Control	16 Mode (Internal)
Remote Switch	3-pin Terminal Block : On, Off, IGN
Surge Protection	Up to 80V/1ms Transient Power
<b>Others</b>	
TPM	Optional Infineon SLB9665 supports TPM 2.0, LPC interface
Watchdog Timer	Reset : 1 to 255 sec./min. per step
Smart Management	Wake on LAN, PXE supported
HW Monitor	Monitoring temperature, voltages. Auto throttling control when CPU overheats.
<b>Software Support</b>	
OS	Windows 10, Linux
<b>Mechanical</b>	
Dimension	260mm x 215mm x 104.1mm (10.2" x 8.5" x 4.1")
Weight	5.8 kg (12.79 lb)
Mounting	<ul style="list-style-type: none"> <li>• Wallmount by mounting bracket</li> <li>• DIN Rail Mount (Optional)</li> </ul>
<b>Environment</b>	
Operating Temperature	<b>35W TDP CPU</b> : -20°C to 60°C (-4°F to 140°F) <b>65W TDP CPU</b> : -20°C to 55°C (-4°F to 131°F) <b>80W TDP CPU</b> : -20°C to 45°C (-4°F to 113°F)
Storage Temperature	-40°C to 85°C (-40°F to 185°F)
Humidity	5% to 95% humidity, non-condensing
Relative Humidity	95% at 60°C
Shock	<ul style="list-style-type: none"> <li>• IEC 60068-2-27</li> <li>• SSD : 50G @wallmount, Half-sine, 11ms</li> </ul>
Vibration	<ul style="list-style-type: none"> <li>• IEC 60068-2-64</li> <li>• SSD : 5Grms, 5Hz to 500Hz, 3 Axis</li> </ul>
EMC	CE, FCC, EN50155, EN50121-3-2

## 1.4 Supported CPU List

Series	CPU	Cores	GHz	TDP (W)	CPU	Cores	GHz	TDP (W)	ECC RAM
Intel® Xeon®	E-2176G	6	4.6	80	E-2278GE	8	4.7	80	Yes
					E-2278GEL	8	3.9	35	
	E-2124G	4	4.5	71	E-2226GE	6	4.6	80	
Intel® Core™	i7-8700	6	4.6	65	i7-9700E	8	4.4	65	N/A
	i7-8700T	6	4	35	i7-9700TE		3.8	35	
	i5-8500	6	4.1	65	i5-9500E	6	4.2	65	
	i5-8500T	6	3.5	35	i5-9500TE		3.6	35	
	i3-8100	4	3.6	65	i3-9100E	4	3.7	65	Yes
	i3-8100T	4	3.1	35	i3-9100TE		3.2	35	

## 1.5 Mechanical Dimension

### 1.5.1 Dimensions of ECX-1420

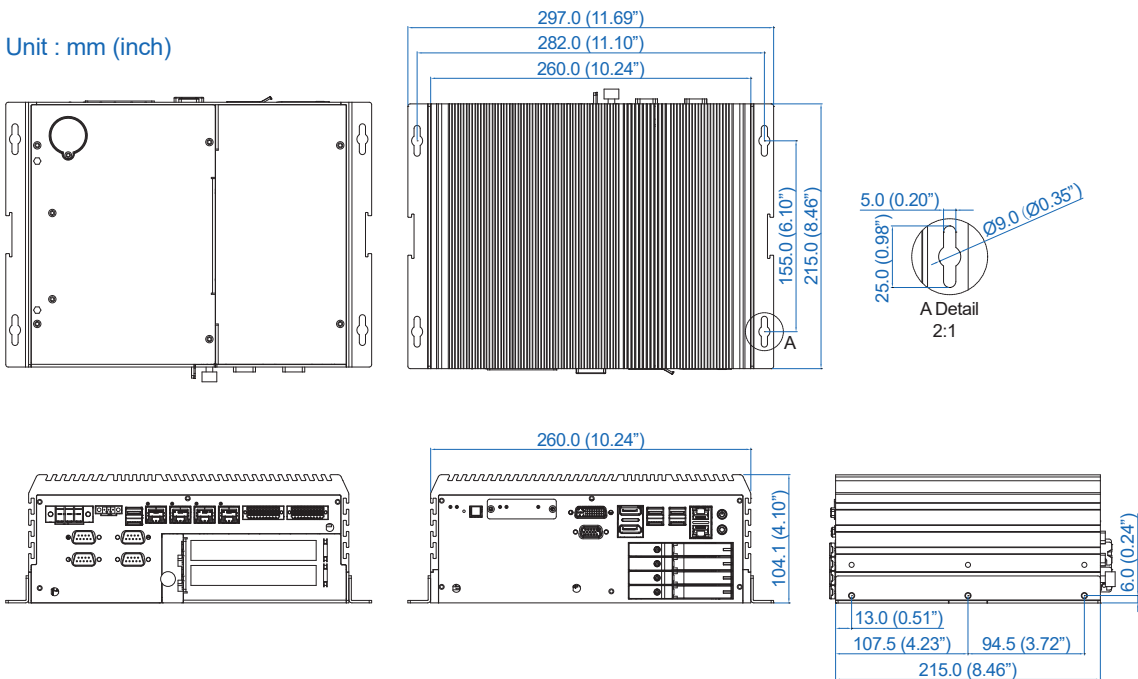

## 1.5.2 Dimensions of ECX-1411

Unit : mm (inch)

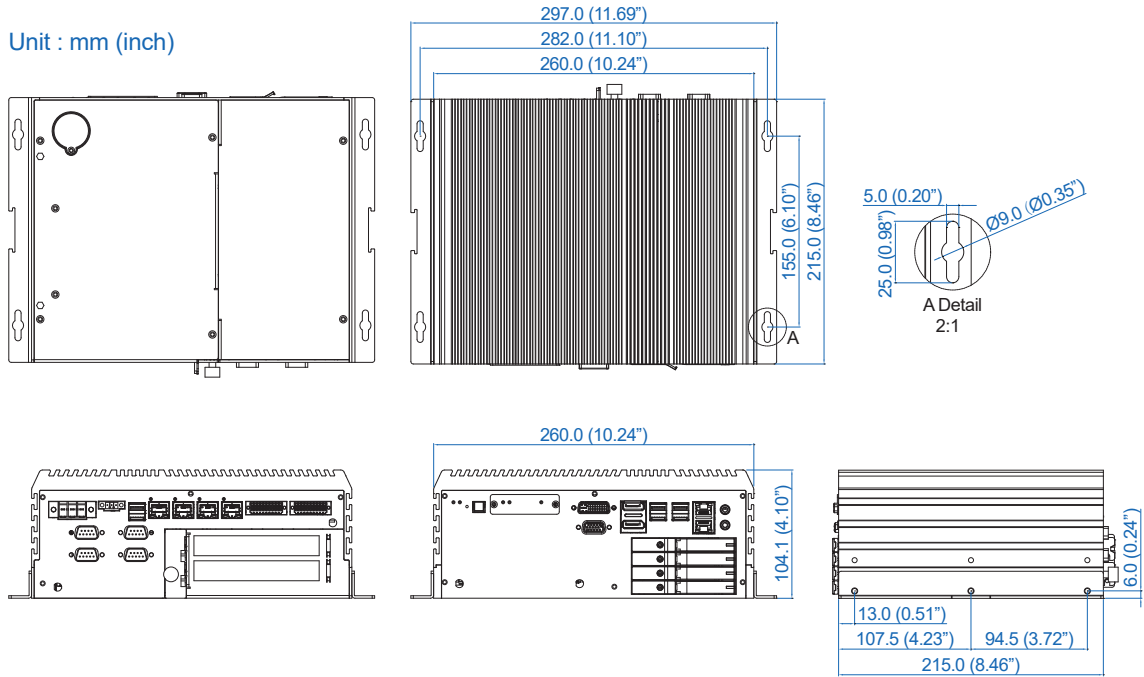

## 1.5.3 Dimensions of ECX-1402

Unit : mm (inch)

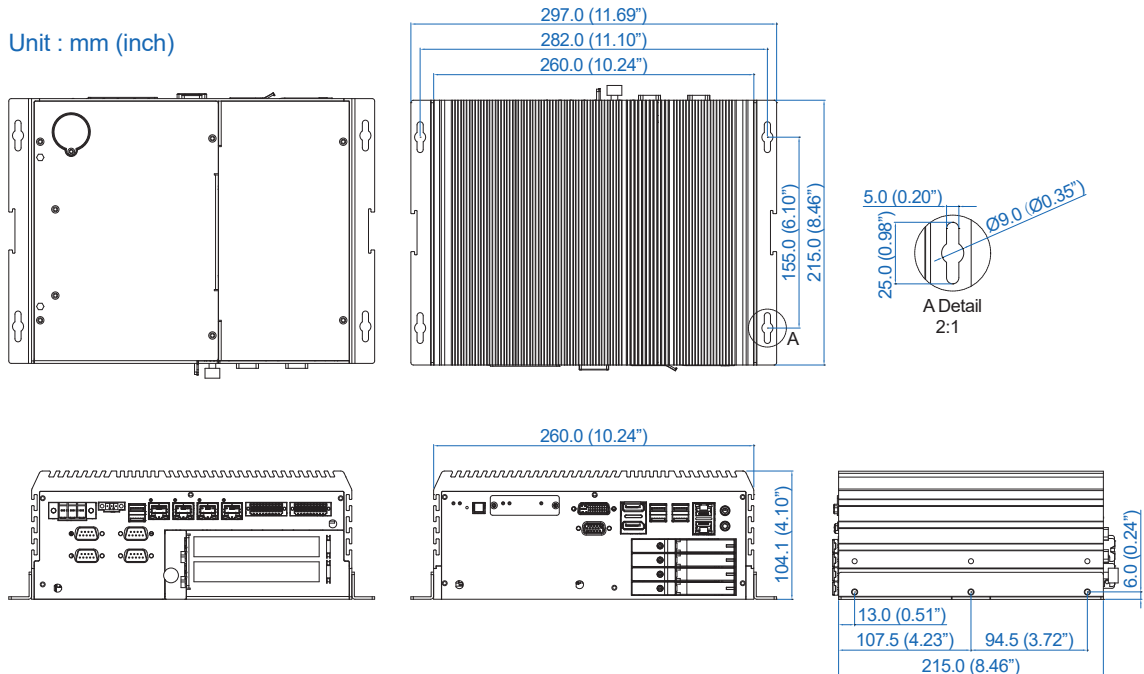

### 1.5.4 Dimensions of ECX-1320

Unit : mm (inch)

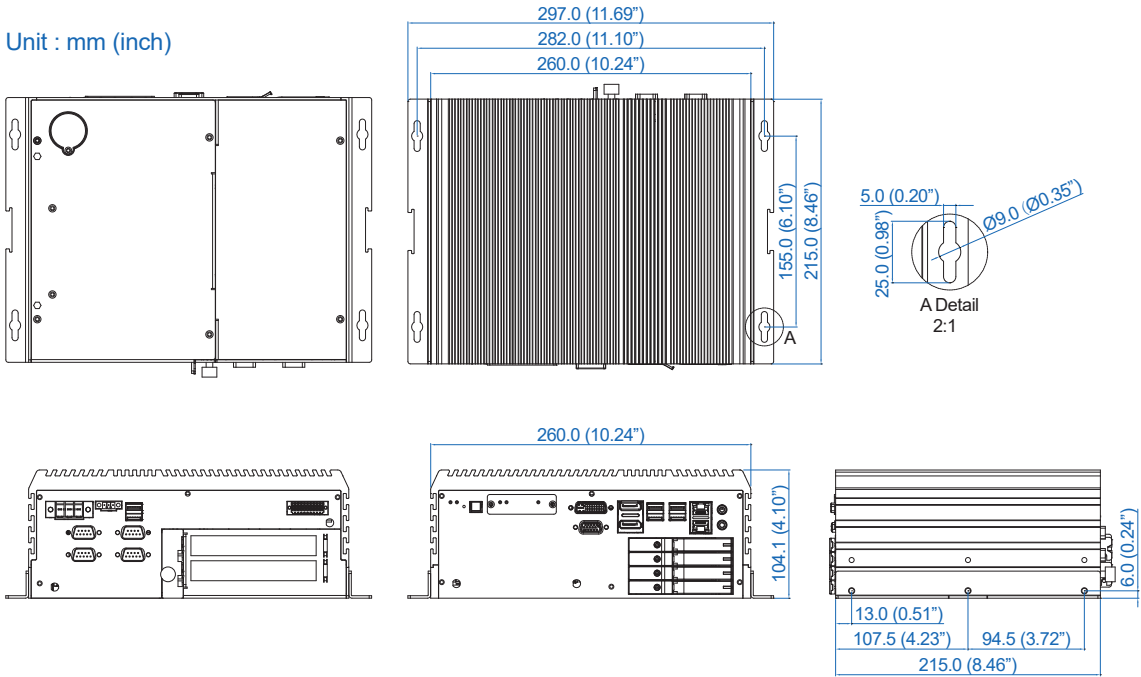

### 1.5.5 Dimensions of ECX-1311

Unit : mm (inch)

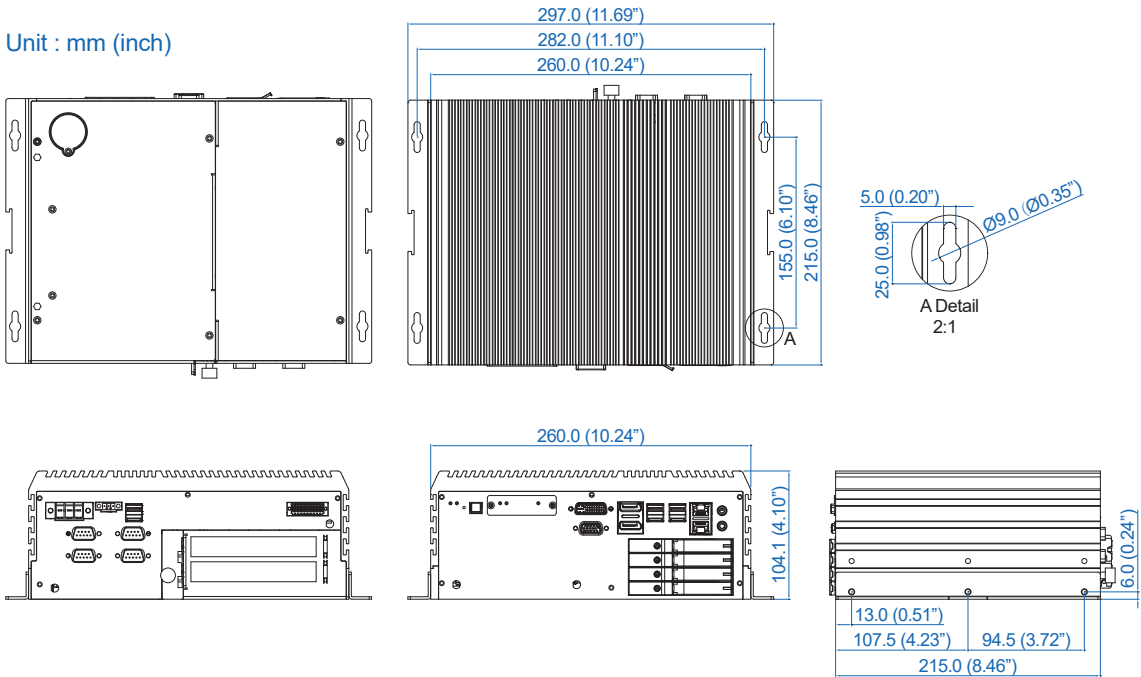

## 1.5.6 Dimensions of ECX-1302

Unit : mm (inch)

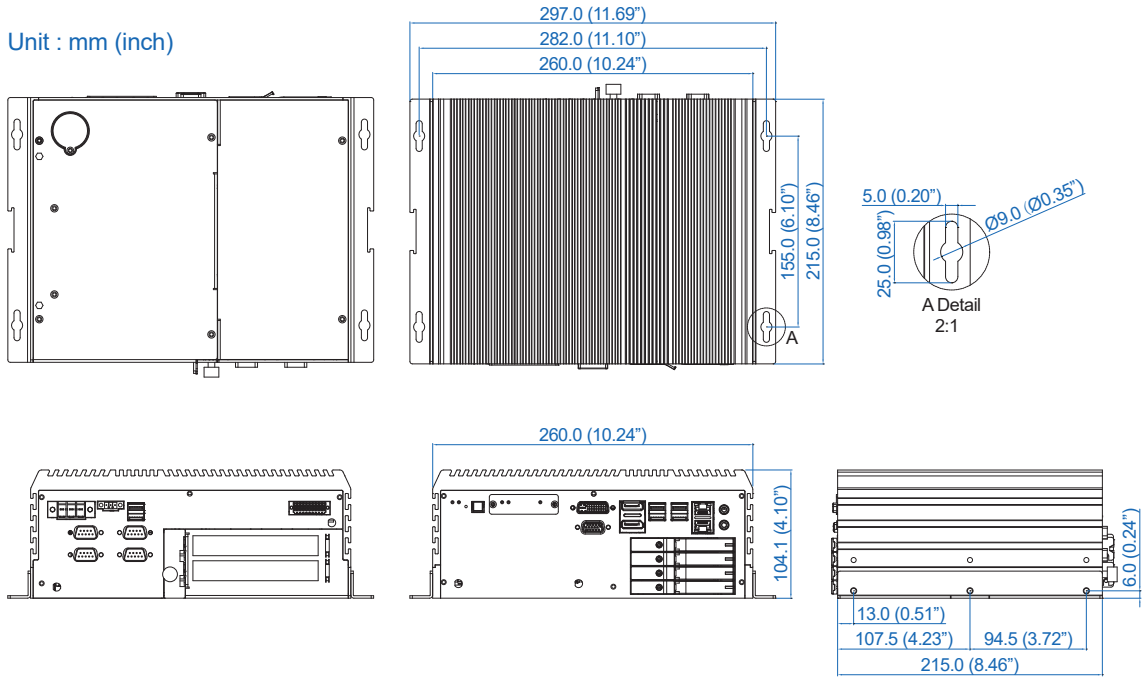

## 1.5.7 Dimensions of ECX-1400 GTX1070

Unit : mm (inch)

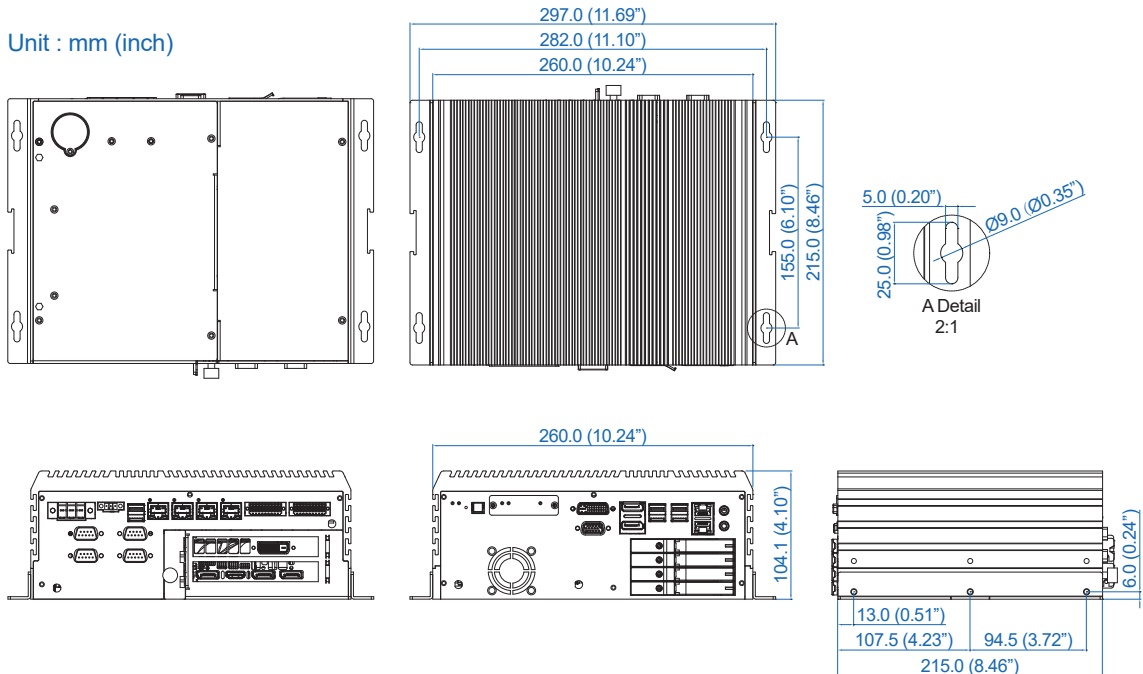

### 1.5.8 Dimensions of ECX-1300 GTX1070

Unit : mm (inch)

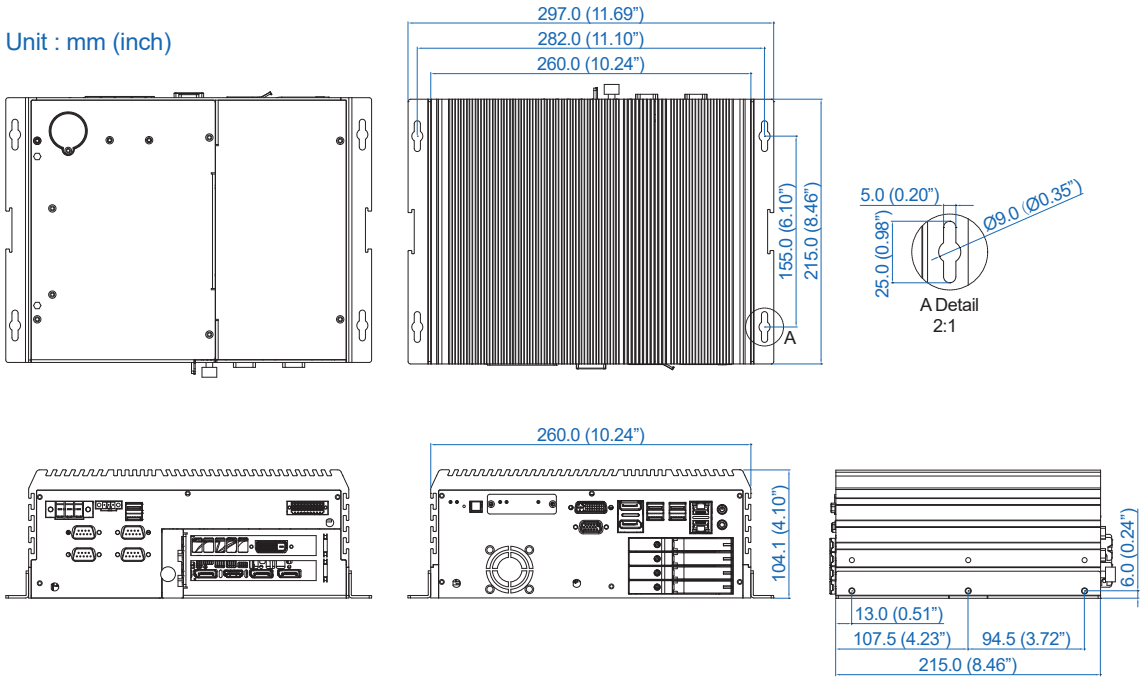

### 1.5.9 Dimensions of ECX-1410 GTX1050

Unit : mm (inch)

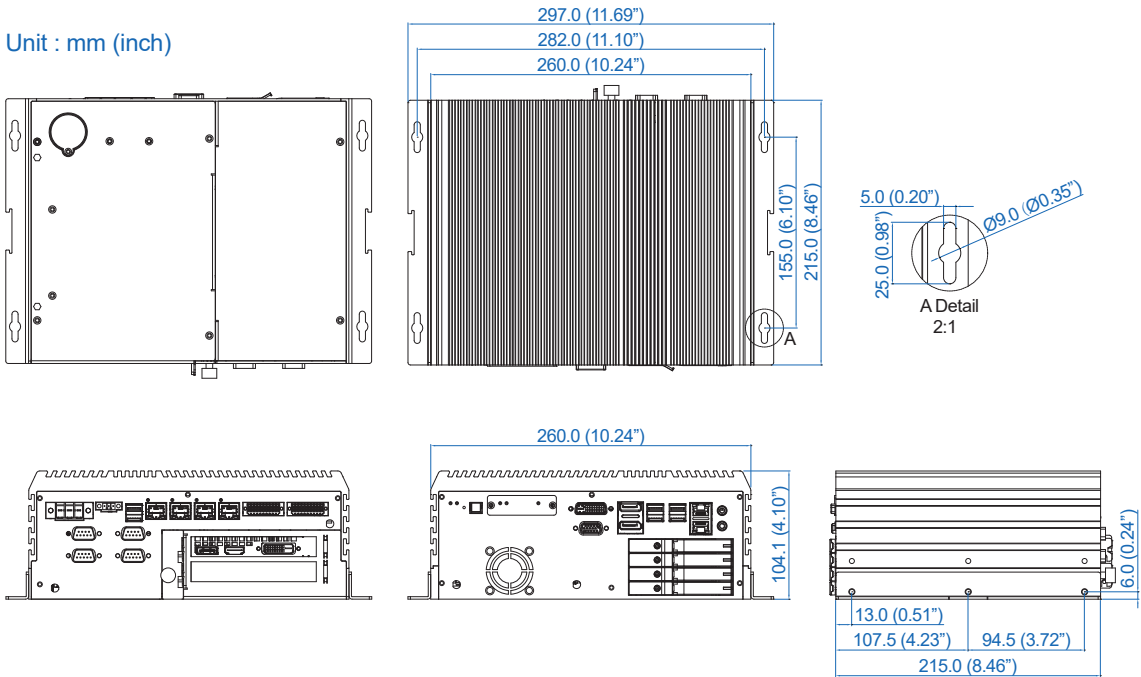

### 1.5.10 Dimensions of ECX-1401 GTX1050

Unit : mm (inch)

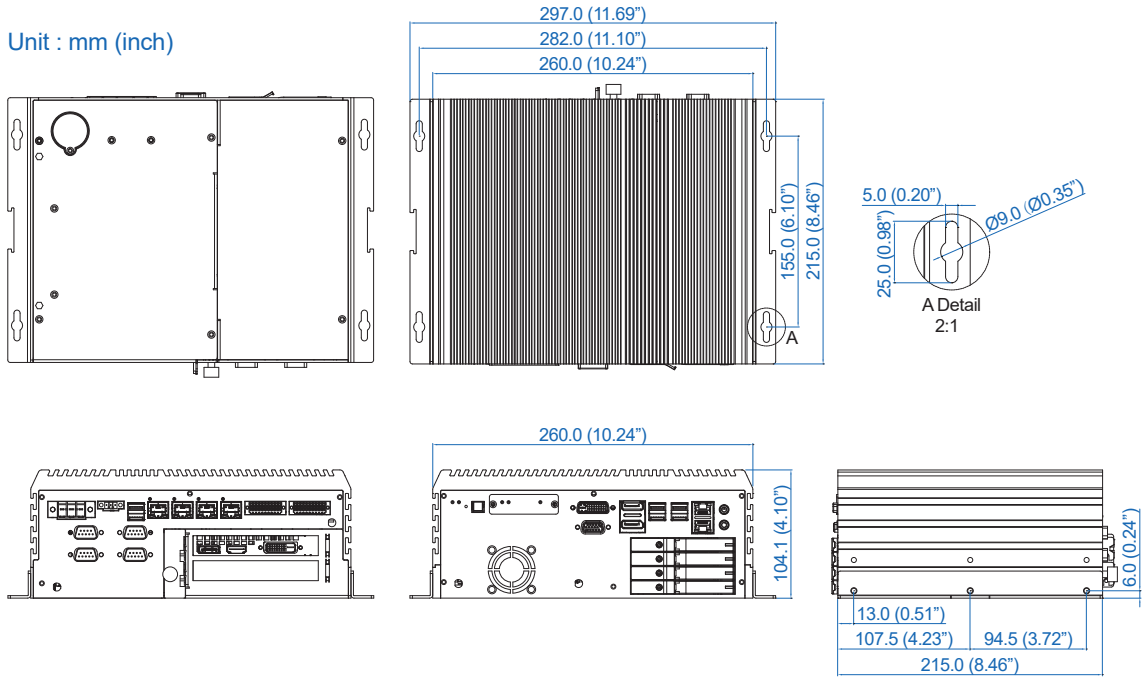

### 1.5.11 Dimensions of ECX-1310 GTX1050

Unit : mm (inch)

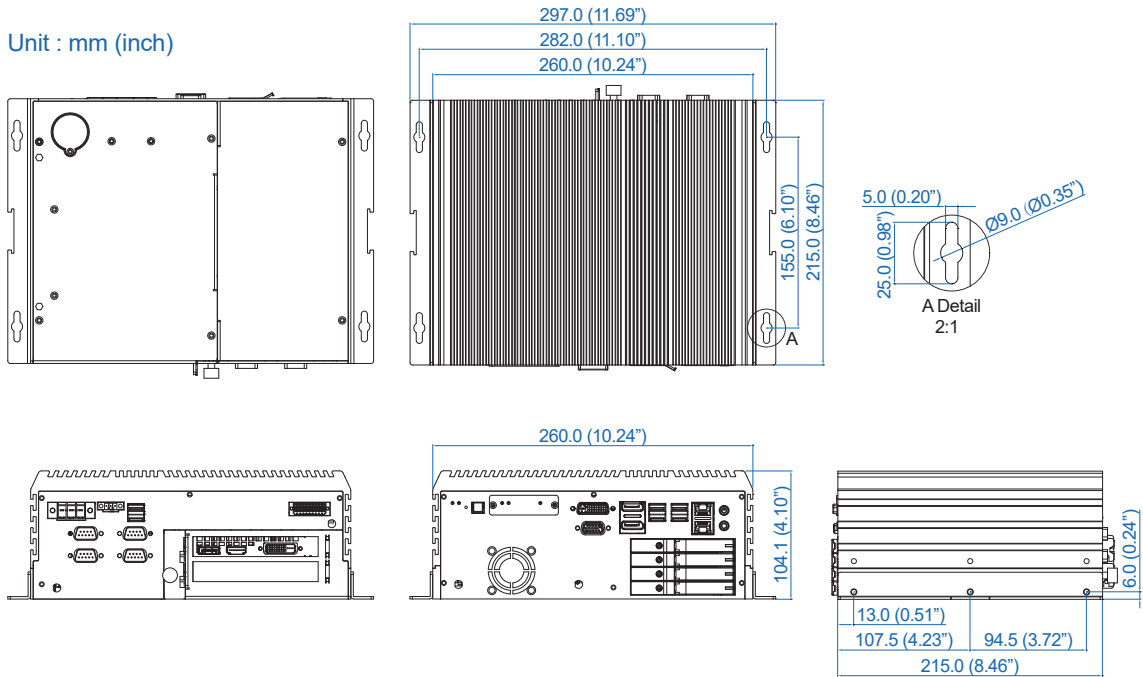



## 1.5.12 Dimensions of ECX-1301 GTX1050

Unit : mm (inch)

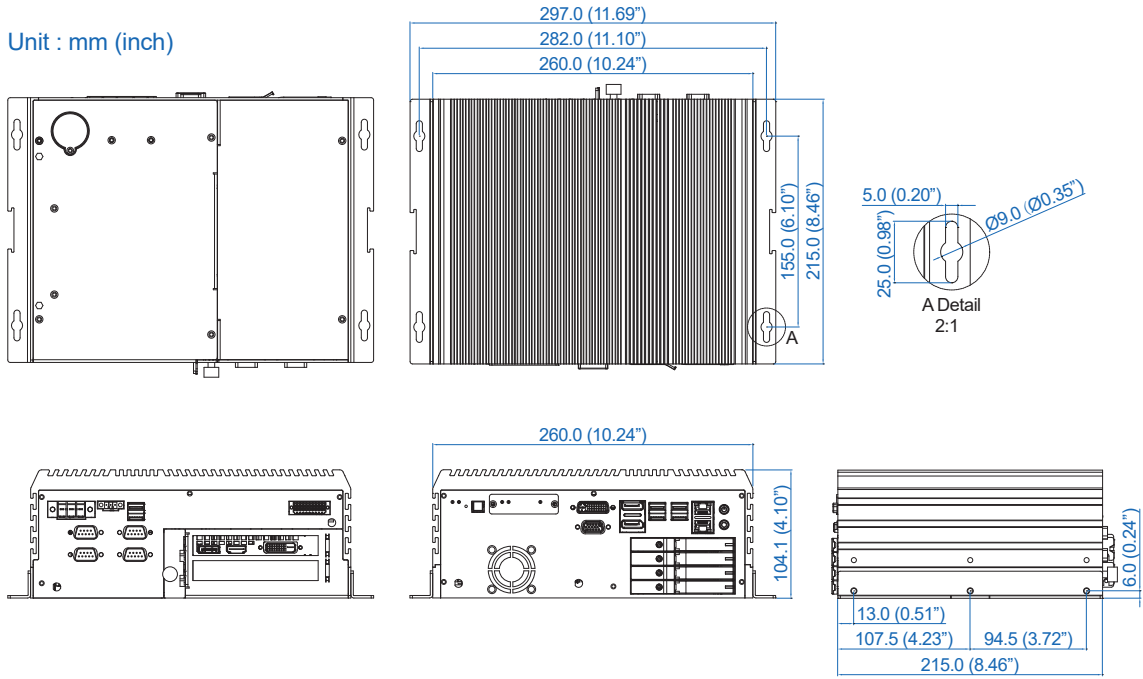

# 2

## GETTING TO KNOW YOUR ECX-1400/1300

### 2.1 Packing List

Item	Description	Qty
1	ECX-1400 Expandable Fanless Embedded System (According to the configuration of you order, the ECX-1400 series may contain SSD/ HDD and DDR4 SO-DIMM. Please verify these items if necessary.)	1

Item	Description	Outlook	Usage	P/N	Qty
1	PHILLPIS M4x16L with washer, Ni		Mount	53-24D6416-30B	4
2	PHILLPIS M2.5x6L, Ni		Mini PCIe slot	53-2426906-30B	4
3	PHILLPIS M3x6L, Ni+Ny		M.2	53-2426206-80B	3
4	PHILLPIS #10-32x6L, Ni		Wall mount bracket	53-I000510-000	6
5	Terminal block 3-pin (7.62mm)		DC-IN	51-2611R03-S1N	1
6	Terminal block 3-pin (3.5mm)		Switch	51-2211R03-S1A	1
7	Terminal block 20-pin (2.54mm)		Isolated DIO/ GPIO	51-2112R20-S1D	2
8	Foot Pad		Foot pad	53-4000042-303	4
9	Wall-mounting bracket		Mount	62-00P0047-000	2
10	Key		SSD/HDD tray	N/A	4

Item	Description	Qty
1	ECX-1300 Expandable Fanless Embedded System (According to the configuration of you order, the ECX-1300 series may contain SSD/ HDD and DDR4 SO-DIMM. Please verify these items if necessary.)	1

Item	Description	Outlook	Usage	P/N	Qty
1	PHILLPIS M4x16L with washer, Ni		Mount	53-24D6416-30B	4
2	PHILLPIS M2.5x6L, Ni		Mini PCIe slot	53-2426906-30B	4
3	PHILLPIS M3x6L, Ni+Ny		M.2	53-2426206-80B	3
4	PHILLPIS #10-32x6L, Ni		Wall mount bracket	53-I000510-000	6
5	Terminal block 3-pin (7.62mm)		DC-IN	51-2611R03-S1N	1
6	Terminal block 3-pin (3.5mm)		Switch	51-2211R03-S1A	1
7	Terminal block 20-pin (2.54mm)		Isolated DIO/ GPIO	51-2112R20-S1D	1
8	Foot Pad		Foot pad	53-4000042-303	4
9	Wall-mounting bracket		Mount	62-00P0047-000	2
10	Key		SSD/HDD tray	N/A	4

## 2.2 Front Panel I/O Functions

In Vecow ECX-1300/1400 series family, all I/O connectors are located on front panel and rear panel. Most of the general connections to computer device, such as USB, LAN Jack, Display, DVI-D, VGA, Display Port and any additional storage, are placed on the front panel.

### 2.2.1 Reset Tact Switch

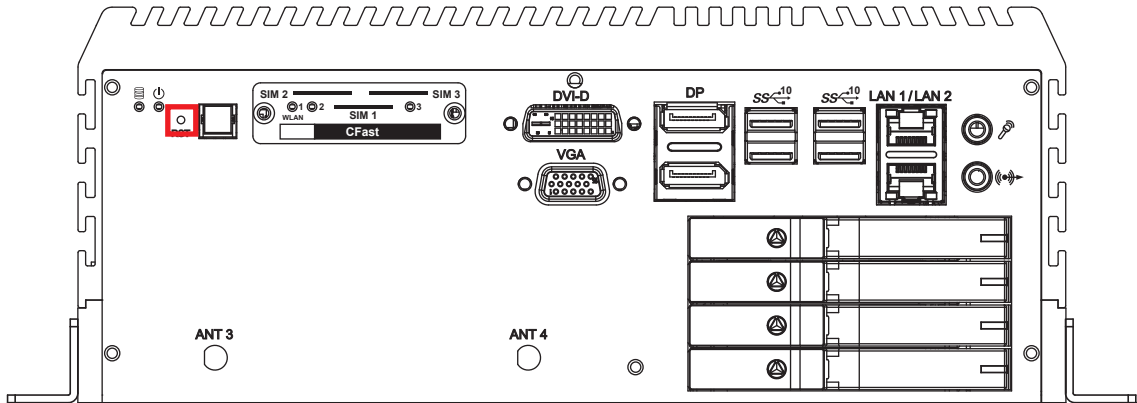

### 2.2.2 Power Button

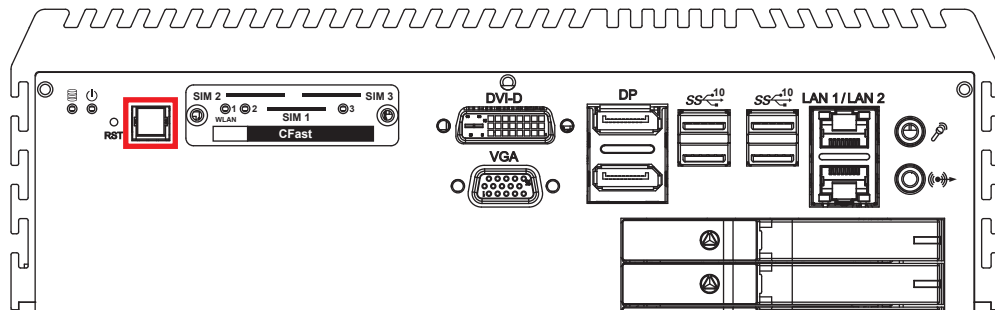

S3 and S5. More detail LED indications are listed as follows :

LED Color	Power Status	System Status
Solid Blue	S0	System working
Solid Orange	S3, S5	Suspend to RAM, System off with standby power

To power on the system, press the power button and then the blue LED is lightened. To power off the system, you can either command shutdown by OS operation, or just simply press the power button. If system error, you can just press the power button for 4 seconds to shut down the machine directly.

Please do note that a 4-second interval between each 2 power-on/power-off operation is necessary in normal working status. (For example, once turning off the system, you have to wait for 4 seconds to initiate another power-on operation).

## 2.2.3 CFast Card

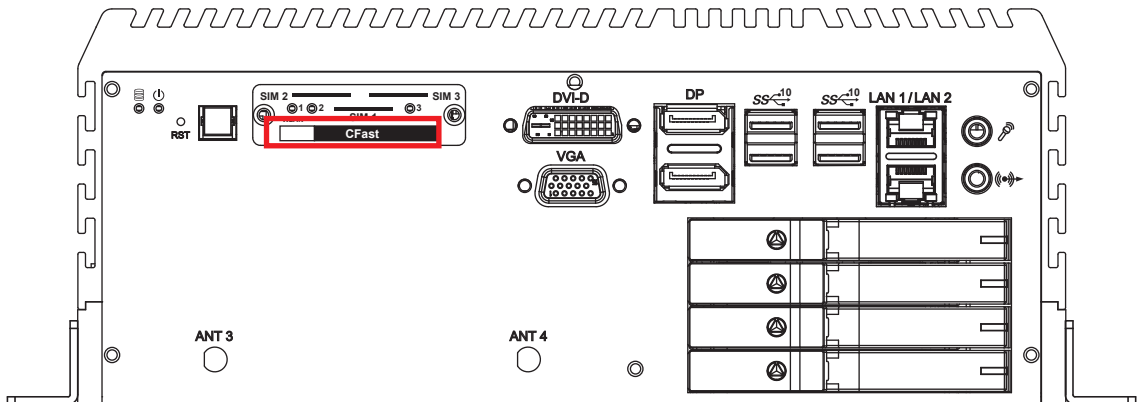

There is a CFast socket on the front panel supporting Type-I/II Compact Flash card. It is implemented by a SATA III Port from C246 PCH. Be sure to disconnect the power source and unscrew the CFast socket cover before installing a CFast card. The ECX-1300/1400 does not support the CFast hot swap and PnP (Plug and Play) functions. It is necessary to remove power source first before inserting or removing the CFast card.

The pinouts of CFast port are listed as follows :

Pin No.	Description	Pin No.	Description
S1	GND	PC6	NC
S2	SATA_TXP6	PC7	GND
S3	SATA_TXN6	PC8	CFAST_LED
S4	GND	PC9	NC
S5	SATA_RXN6	PC10	NC
S6	SATA_RXP6	PC11	NC
S7	GND	PC12	NC
PC1	GND	PC13	+3.3V
PC2	GND	PC14	+3.3V
PC3	NC	PC15	GND
PC4	NC	PC16	GND
PC5	NC	PC17	NC

## 2.2.4 PWR & HDD LED Indicator

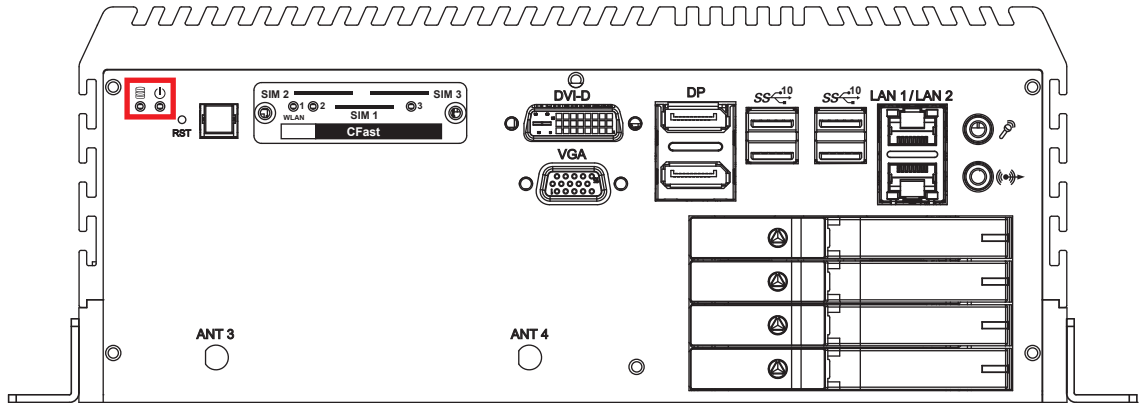

**HDD LED/Yellow** : A Hard Disk/CFast LED. If the LED is on, it indicates that the system's storage is functional. If it is off, it indicates that the system's storage is not functional. If it is flashing, it indicates data access activities.

**Power LED/Green** : If the LED is solid green, it indicates that the system is powered on.

LED Color	Indication	System Status
Yellow	HDD/CFast	<ul style="list-style-type: none"> <li>On/Off : Storage status, function or not.</li> <li>Twinkling : Data transferring.</li> </ul>
Green	Power	System power status (on/off)

## 2.2.5 DVI-D Connector

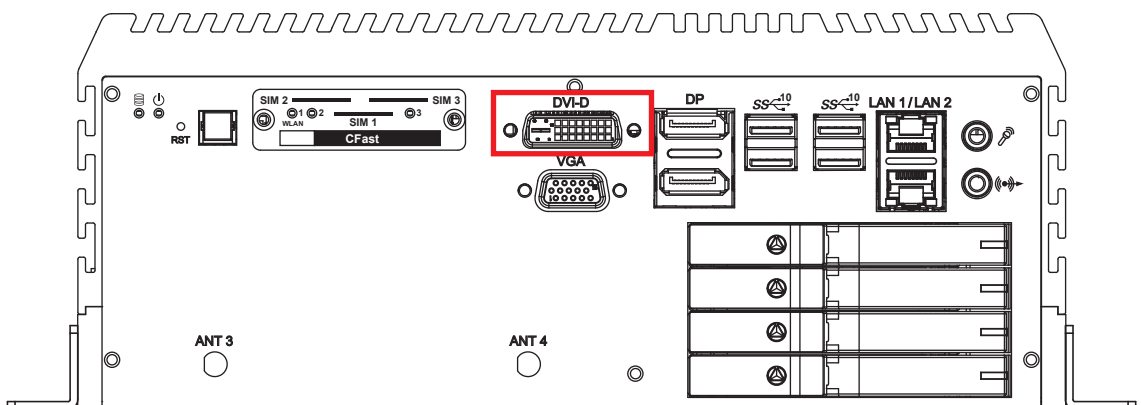

The DVI-D connector on the front panel supports DVI display. This connector can either output DVI signal. The DVI output mode supports up to 1920 x 1200 resolution and output mode supports up to 1920 x 1200 resolution. The DVI is automatically selected according to the display device connected. You will need a DVI-D cable when connecting to a display device.

## 2.2.6 VGA Connector

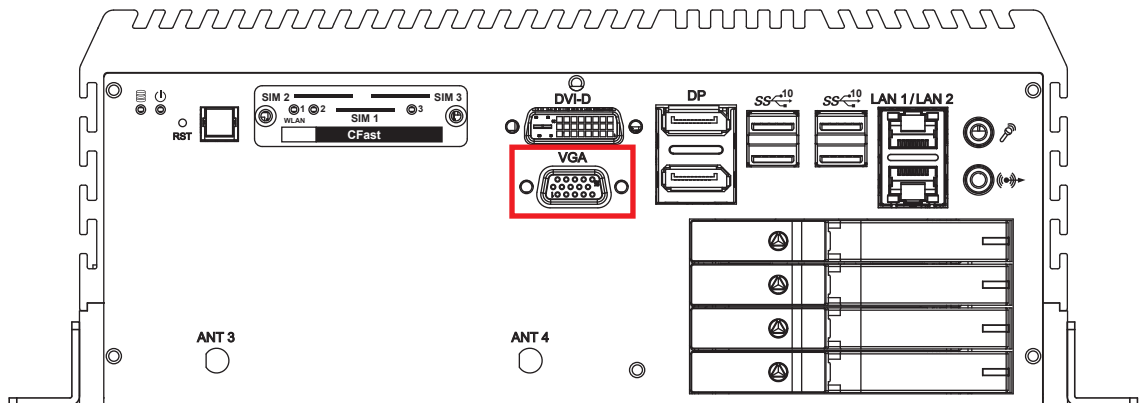

The ECX-1300/1400 series comes with a DB15 female connector on the front panel to connect a VGA monitor. To ensure that the monitor image remains clear, be sure to tighten the monitor cable after connecting it to the ECX-1300/1400 series. The VGA output mode supports up to 1920x1200 resolutions. The pin assignments of the VGA connector are shown below.

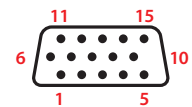

Pin No.	Description	Pin No.	Description
1	Red Color Signal	2	Green Color Signal
3	Blue Color Signal	4	NC
5	Ground	6	Ground
7	Ground	8	Ground
9	VCC	10	Ground
11	NC	12	DDC-DATA
13	H-Sync.	14	V-Sync.
15	DDC-CLK		

## 2.2.7 DisplayPort

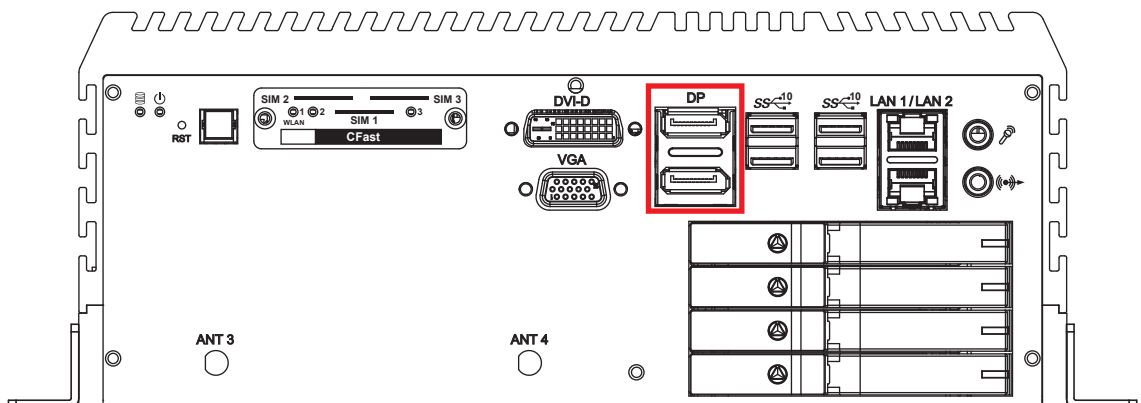

Onboard Display Port support auxiliary channel dual mode, connection supports up to 4096x2304 resolution at 60 Hz.

## 2.2.8 USB 3.1

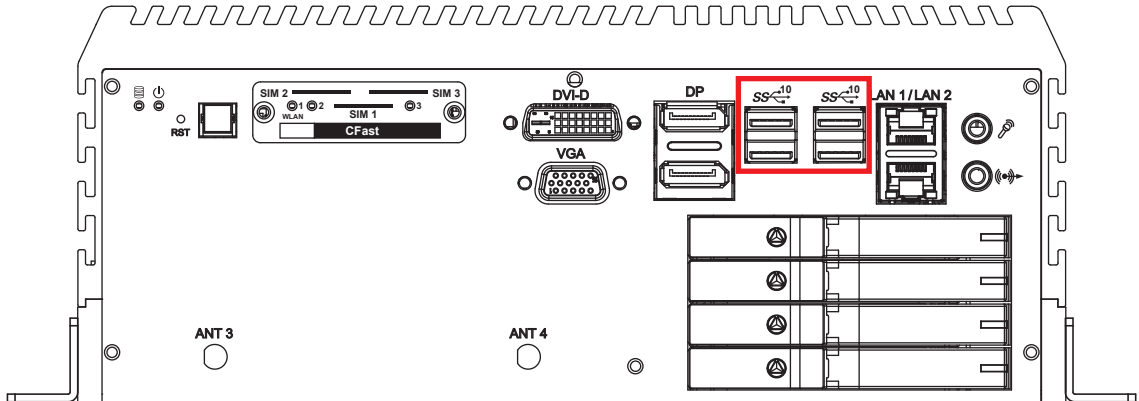

There are 4 USB 3.1 connections available supporting up to 10GB per second data rate in the front side of ECX-1300/1400. It also compliant with the requirements of Super Speed (SS), high speed (HS), full speed (FS) and low speed (LS).

## 2.2.9 WLAN LED, Mini PCIe, SIM Card Comparison

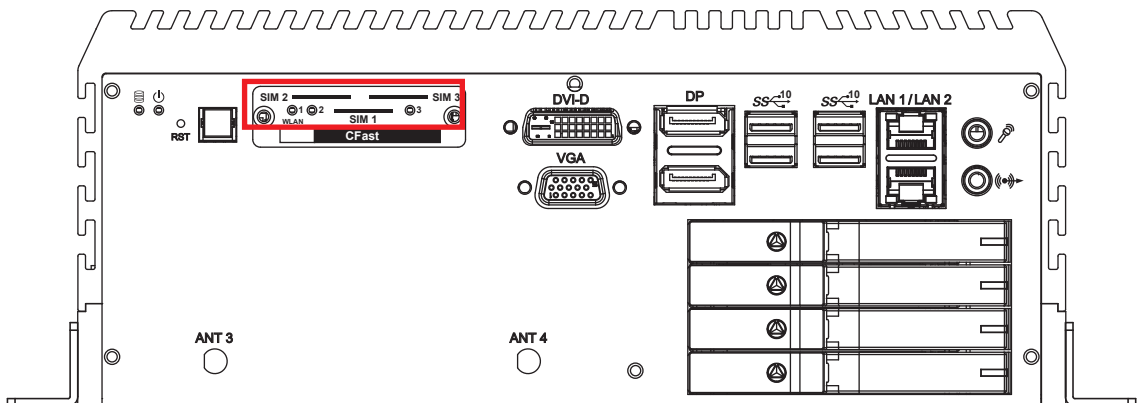

Mini PCIe Slot/SIM Slot/WLAN LED Mapping Table :

Mini PCIe	SIM	LED
MPCle 1	SIM 1 (CN19)	1
MPCle 2	SIM 2 (CN20)	2
M.2 KEY B	SIM 3 (CN21)	3

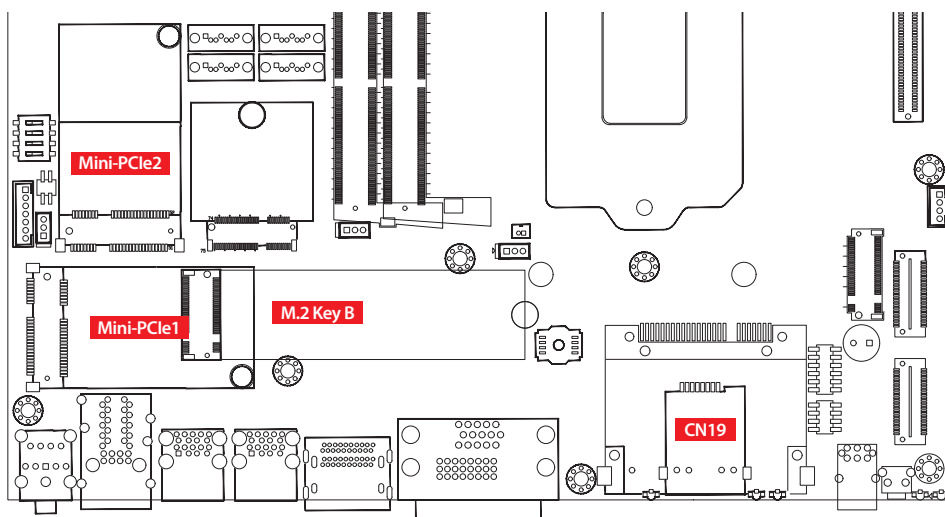
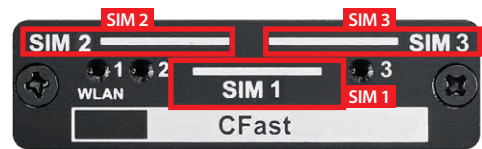



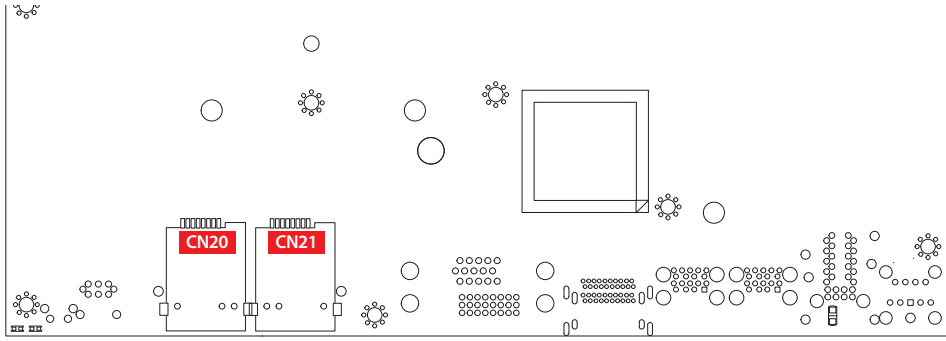

**Note :**  
The SIM card sockets do not support hot-plug. Please make sure to unplug the system power before inserting the SIM card(s).

## 2.2.10 Ethernet Port

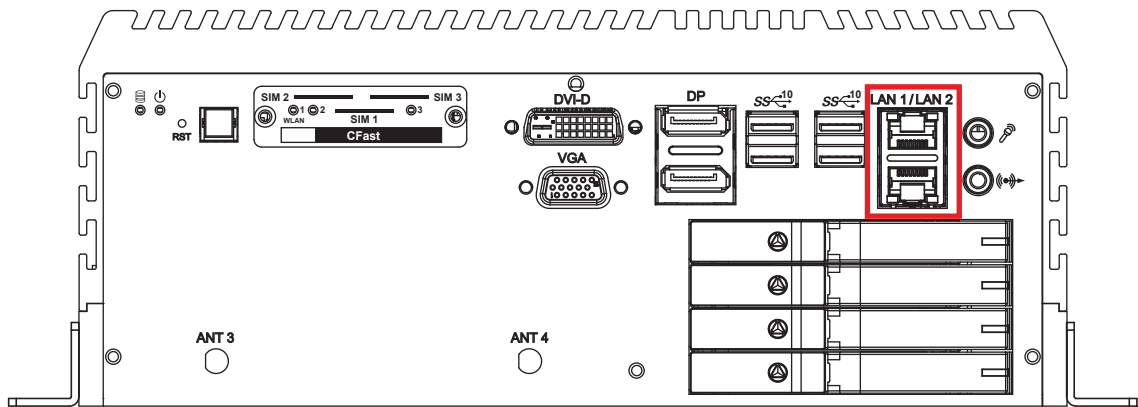

There are 2 8-pin RJ-45 jacks supporting 10/100/1000 Mbps Ethernet connections in the front side. LAN 1 is powered by Intel® i219 Ethernet Phy; LAN 2 is powered by Intel® I210 Ethernet engine. When both LAN 1 and LAN 2 work in normal status, iAMT 12.0 function is enabled.

Using suitable RJ-45 cable, you can connect the system to a computer, or to any other devices with Ethernet connection, for example, a hub or a switch. Moreover, both of LAN 1 and LAN 2 supports Wake on LAN and Pre-boot functions. The pin-outs of LAN 1 and LAN 2 are listed as follows :

Pin No.	10/100 Mbps	1000Mbps
1	E_TX+	MDI0_P
2	E_TX-	MDI0_N
3	E_RX+	MDI1_P
4	----	MDI2_P
5	----	MDI2_N
6	E_RX-	MDI1_N
7	----	MDI3_P
8	----	MDI3_N

Each LAN port is supported by standard RJ-45 connector with LED indicators to present Active/Link/Speed status of the connection.

The LED indicator on the right bottom corner lightens in solid green when the cable is properly connected to a 100Mbps Ethernet network; The LED indicator on the right bottom corner lightens in solid orange when the cable is properly connected to a 1000Mbps Ethernet network; The left LED will keep twinkling/off when Ethernet data packets are being transmitted/received.

LED Location	LED Color	10Mbps	100Mbps	1000Mbps
Right	Green/ Orange	Off	Solid Green	Solid Orange
Left	Green	Twinkling Green	Twinkling Green	Twinkling Green

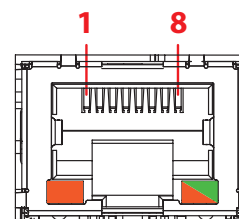

### 2.2.11 Audio Connector

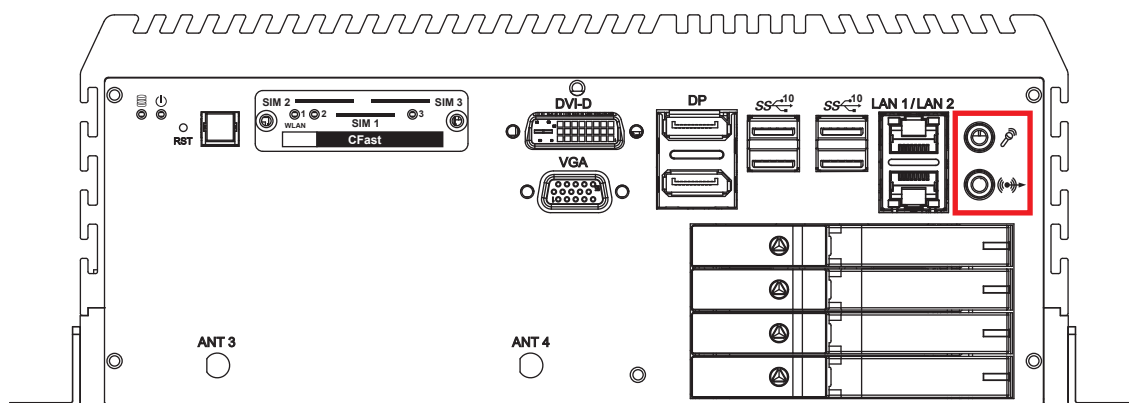

There are 2 audio connectors, Mic-in and Line-out, in the front side of ECX-1300/1400 series. Onboard Realtek ALC888S-VD audio codec supports 7.1 channel HD audio and fully complies with Intel® High Definition Audio (Azalia) specifications.

To utilize the audio function in Windows platform, you need to install corresponding drivers for both Intel® Sunrise Point chipset and Realtek ALC888S-VD codec.

### 2.2.12 SSD/HDD Tray

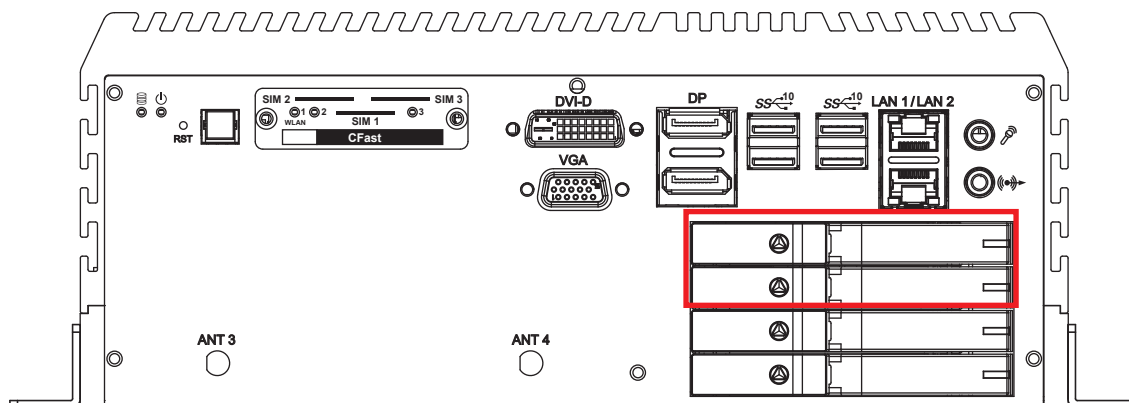

There are 4 front-access 2.5" SSD/HDD trays in the front side of ECX-1300/1400 series. Just trigger to open the SSD/HDD tray, up to 4TB is available.

## 2.3 Rear Panel I/O & Functions

### 2.3.1 Power Terminal Block

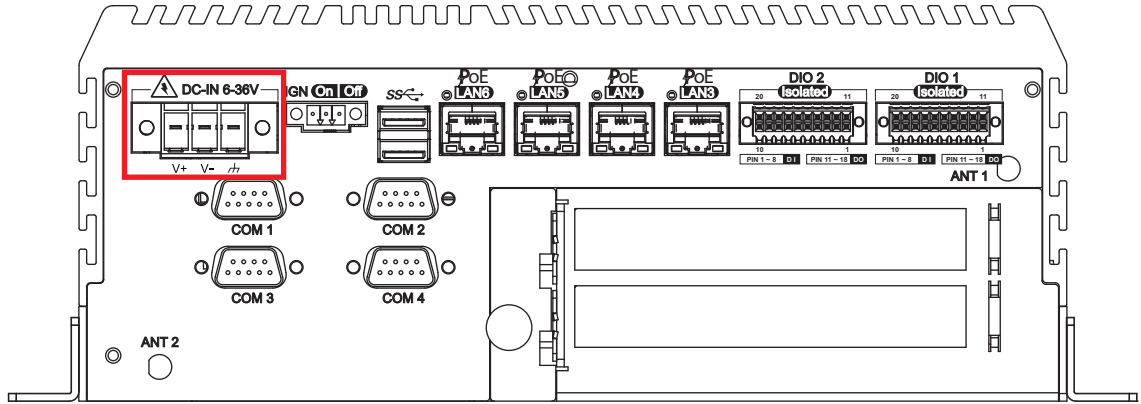

This system supports 6V to 36V DC power input by terminal block in the rear side. In normal power operation, power LED lightens in solid green. Supports up to 80V surge protection.

Pin No.	Definition	Pin No.	Definition
1	V+	2	V-
3	Chassis Ground		

### 2.3.2 Remote Power On/Off Switch & LED Terminal Block

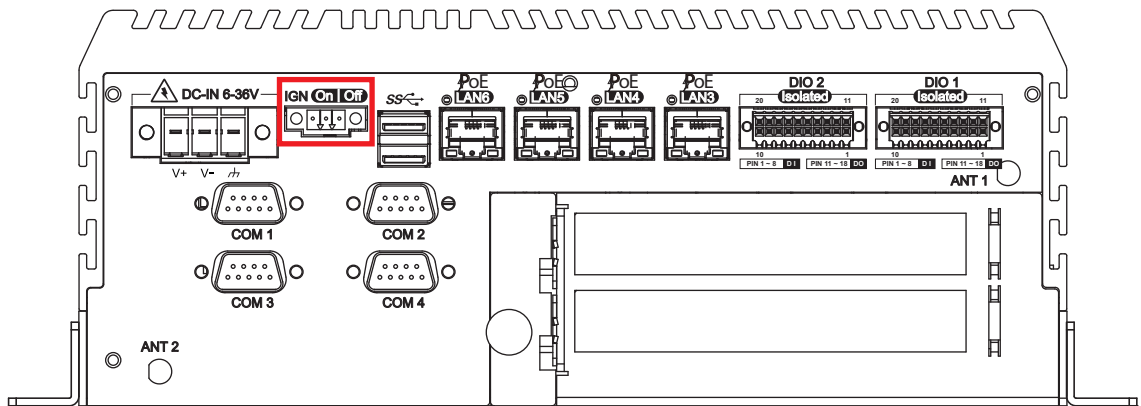

It is a 2-pin power-on or power-off switch through Phoenix Contact terminal block. You could turn on or off the system power by using this contact. This terminal block supports dual function of soft power-on/power-off (instant off or delay 4 second), and suspend mode.

Pin No.	Definition	Pin No.	Definition
1	Ignition	2	SW+
3	SW-		

## 2.3.3 Isolated DIO/GPIO

### 2.3.3.1 Isolated DIO

ECX-1400 series :

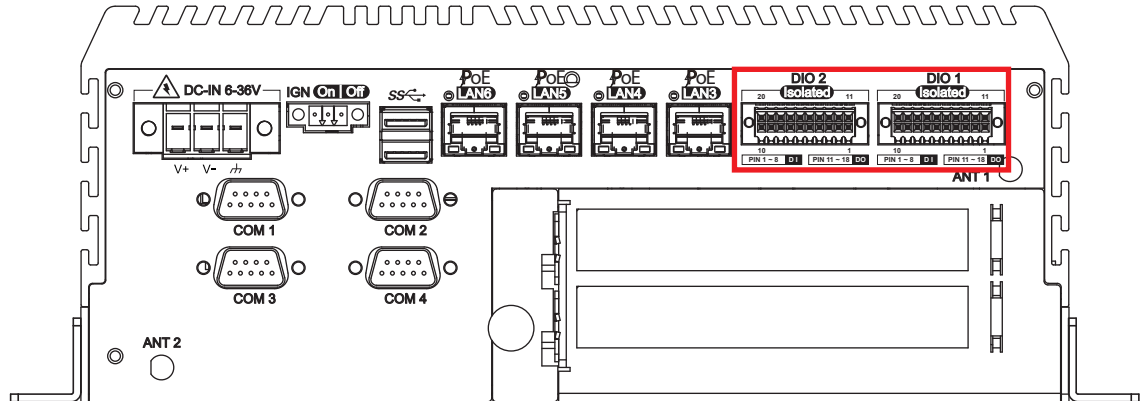

There is a 16-bit (8-bit DI, 8-bit DO) connectors in the rear side of ECX-1400. DI/ DIO support NPN (sink) and PNP (Source) mode, Each DI channel is equipped with a photocouper for isolated protection. Each DO with isolator chip, Config by a Jumper for each DIO connector.

DO Safety-Related Certifications :

- 4242-VPK Basic Isolation per DIN V VDE V 0884-10 and DIN EN 61010-1
- 3-KVRMS Isolation for 1 minute per UL 1577
- CSA Component Acceptance Notice 5A, IEC 60950-1 and IEC 61010-1 End Equipment Standards
- GB4943.1-2011 CQC Certified

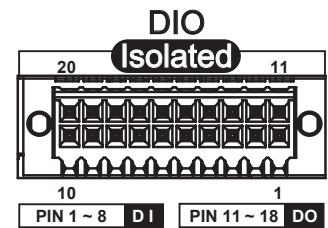

DIO Connectors pin out :

DIO	Pin No.	Definition	Function
DIO 1	1	INPUT 0	SIO_GPI70
	2	INPUT 1	SIO_GPI71
	3	INPUT 2	SIO_GPI72
	4	INPUT 3	SIO_GPI73
	5	INPUT 4	SIO_GPI74
	6	INPUT 5	SIO_GPI75
	7	INPUT 6	SIO_GPI76
	8	INPUT 7	SIO_GPI77
	9	DI_COM	
	10	DIO_GND	

DIO	Pin No.	Definition	Function
DIO 1	11	OUTPUT 0	SIO_GPO80
	12	OUTPUT 1	SIO_GPO81
	13	OUTPUT 2	SIO_GPO82
	14	OUTPUT 3	SIO_GPO83
	15	OUTPUT 4	SIO_GPO84
	16	OUTPUT 5	SIO_GPO85
	17	OUTPUT 6	SIO_GPO86
	18	OUTPUT 7	SIO_GPO87
	19	DIO_GND	-
	20	External 6-40VDC (NPN) External 6-48VDC (PNP)	-
DIO 2	1	INPUT 0	SIO_GPI37
	2	INPUT 1	SIO_GPI56
	3	INPUT 2	SIO_GPI57
	4	INPUT 3	SIO_GPI15
	5	INPUT 4	SIO_GPI16
	6	INPUT 5	SIO_GPI35
	7	INPUT 6	SIO_GPI46
	8	INPUT 7	SIO_GPI11
	9	DI2_COM	-
	10	DIO2_GND	-
	11	OUTPUT 0	SIO_GPO22
	12	OUTPUT 1	SIO_GPO26
	13	OUTPUT 2	SIO_GPO64
	14	OUTPUT 3	SIO_GPO65
	15	OUTPUT 4	SIO_GPO41
	16	OUTPUT 5	SIO_GPO40
	17	OUTPUT 6	SIO_GPO52
	18	OUTPUT 7	SIO_GPO27
	19	DIO2_GND	-
	20	External 6-40VDC (NPN) External 6-48VDC (PNP)	-

DI reference circuit :

Sink Mode  
(NPN)

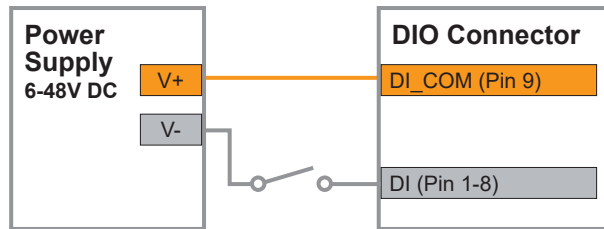

Source Mode  
(PNP)

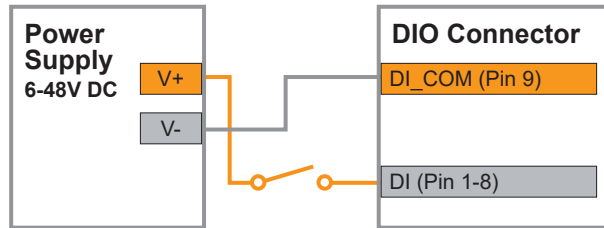

DO reference circuit :

Sink Mode  
(NPN, Default)

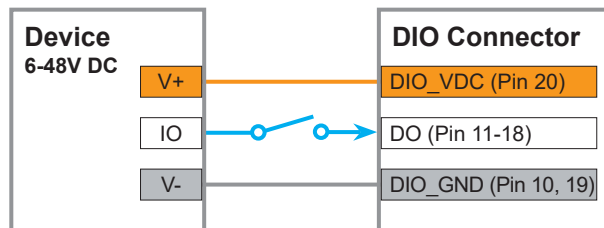

Source Mode  
(PNP)

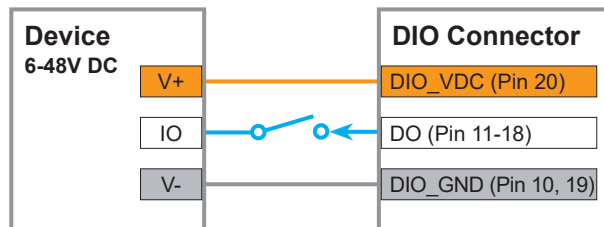

### 2.3.3.2 GPIO

ECX-1300 series :

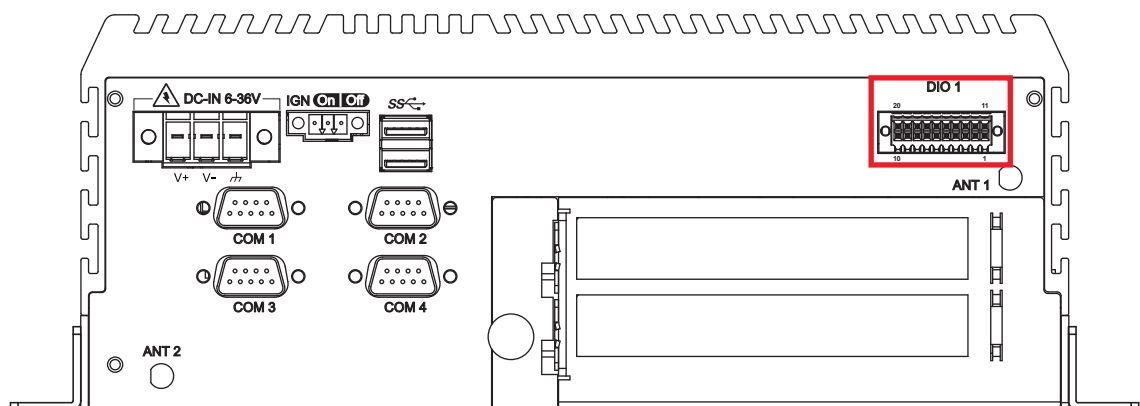

The system offers sixteen programmable I/O (3.3V Level).

If the GPIO is logic high, it indicates that the mapping SIO GPIO pin is logic high level.

If the GPIO is logic low, it indicates that the mapping SIO GPIO pin is logic low level.

### GPIO Connectors pin assignments

Pin No.	Mapping to SIO GPIO Function	Pin No.	Mapping to SIO GPIO Function
1	SIO_GPI37	11	SIO_GPO22
2	SIO_GPI56	12	SIO_GPO26
3	SIO_GPI57	13	SIO_GPO64
4	SIO_GPI15	14	SIO_GPO65
5	SIO_GPI16	15	SIO_GPO41
6	SIO_GPI35	16	SIO_GPO40
7	SIO_GPI46	17	SIO_GPO52
8	SIO_GPI11	18	SIO_GPO27
9	-----	19	GND
10	GND	20	-----

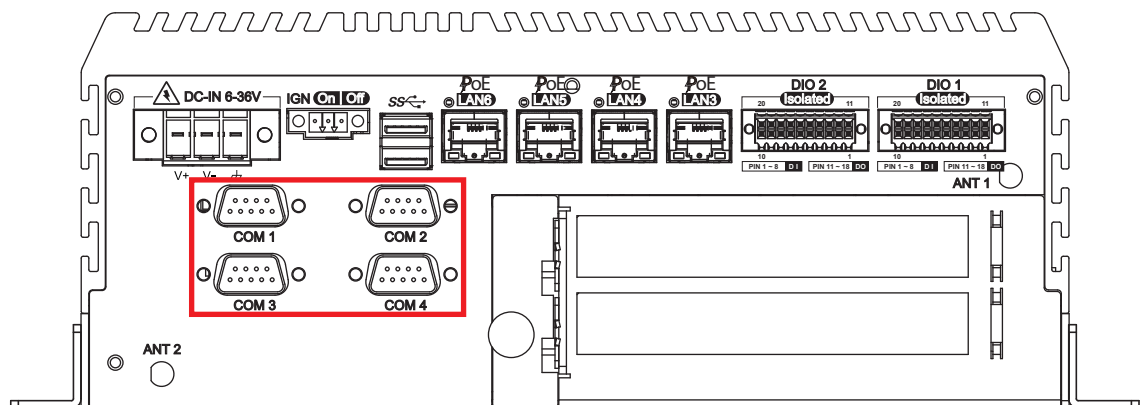

Serial port 1 to 4 (COM 1 to 4) can be configured for RS-232, RS-422, or RS-485 with auto flow control communication. The default definition of COM 1 and COM 2 is RS-232, if you want to change to RS-422 or RS-485, you can find the setting in BIOS.

BIOS Setting	Function
COM 1	RS-232
COM 2	RS-422 (5-wire)
	RS-422 (9-wire)
COM 3	RS-485
COM 4	RS-485 w/z auto-flow control

The pin assignments are listed in the following table :

Serial Port	Pin No.	RS-232	RS-422 (5-wire)	RS-422 (9-wire)	RS-485 (3-wire)
1 to 4	1	DCD	TXD-	TXD-	DATA-
	2	RXD	TXD+	TXD+	DATA+
	3	TXD	RXD+	RXD+	-----
	4	DTR	RXD-	RXD-	-----
	5	GND	GND	GND	GND
	6	DSR	-----	RTS-	-----
	7	RTS	-----	RTS+	-----
	8	CTS	-----	CTS+	-----
	9	RI	-----	CTS-	-----

COM 1 to COM 4 MB connector table :

COM Port	MB Connector	COM Port	MB Connector
COM 1	CN13	COM 2	CN14
COM 3	CN15	COM 4	CN16

	Pin No.	Signal Name
CN13 to CN16	1	NC
	2	GND
	3	RI
	4	DTR
	5	CTS
	6	TXD
	7	RTS
	8	RXD
	9	DSR
	10	DCD

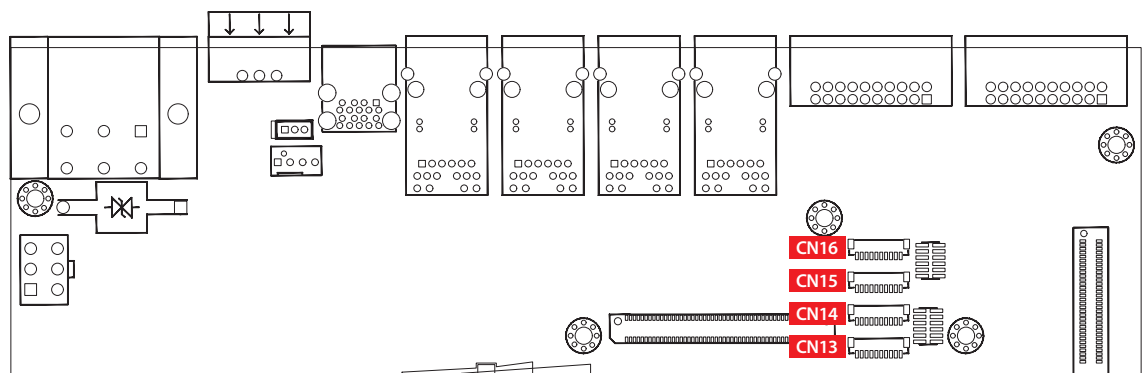



### 2.3.5 PoE Ports

ECX-1400 series :

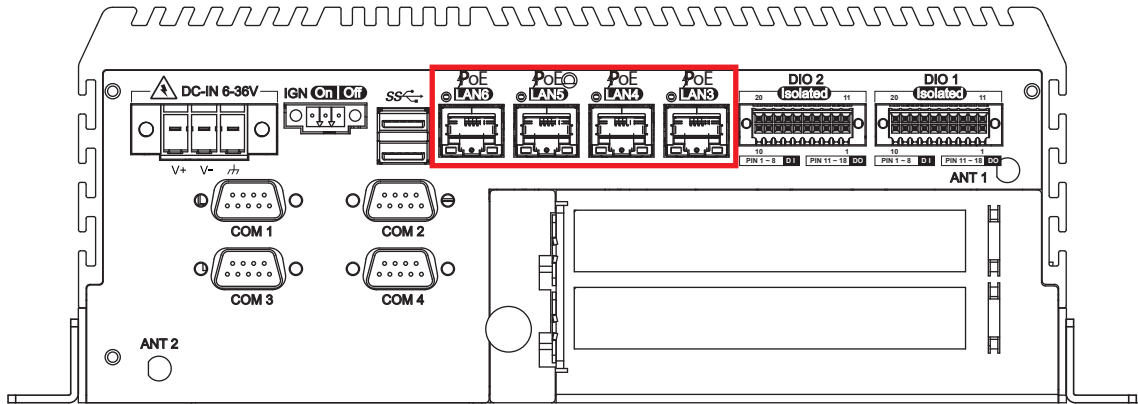

There are 4 RJ45 connectors in the rear side of ECX-1400. It supports IEEE 802.3at (PoE+) Power over Ethernet (PoE) connection delivering up to 37W/54V per port and 1000BASE-T gigabit data signals over standard Ethernet Cat 5/Cat 6 cable.

Each PoE connection is powered by Intel® I350 Gigabit Ethernet controller and independent PCI express interface to connect with multi-core processor for network and data transmit optimization. Only when PoE port starts to supply power to power devices, the dedicated LED will be lightened.

**PS. Suggest to use PoE function when power input is over 12V.**

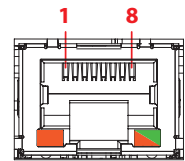

The pin-outs of LAN 3 and LAN 6 are listed as follows :

Pin No.	10/100 Mbps	1000Mbps	PoE
1	E_TX+	MDI0_P	PoE+
2	E_TX-	MDI0_N	PoE+
3	E_RX+	MDI1_P	PoE-
4	----	MDI2_P	----
5	-----	MDI2_N	----
6	E_RX-	MDI1_N	PoE-
7	-----	MDI3_P	----
8	-----	MDI3_N	----

Each LAN port is supported by standard RJ-45 connector with LED indicators to present Active/Link/Speed status of the connection.

The LED indicator on the right bottom corner lightens in solid green when the cable is properly connected to a 100Mbps Ethernet network; The LED indicator on the right bottom corner lightens in solid orange when the cable is properly connected to a 1000Mbps Ethernet network; The left LED will keep twinkling/off when Ethernet data packets are being transmitted/received.

LED Location	LED Color	10Mbps	100Mbps	1000Mbps
Right	Green/Orange	Off	Solid Green	Solid Orange
Left	Yellow	Twinkling Yellow	Twinkling Yellow	Twinkling Yellow

POE LED	LED Color	POE Status
LED 1 - 4	Solid Green	POE ON

### 2.3.6 Add Card

ECX-1420/1411/140 :

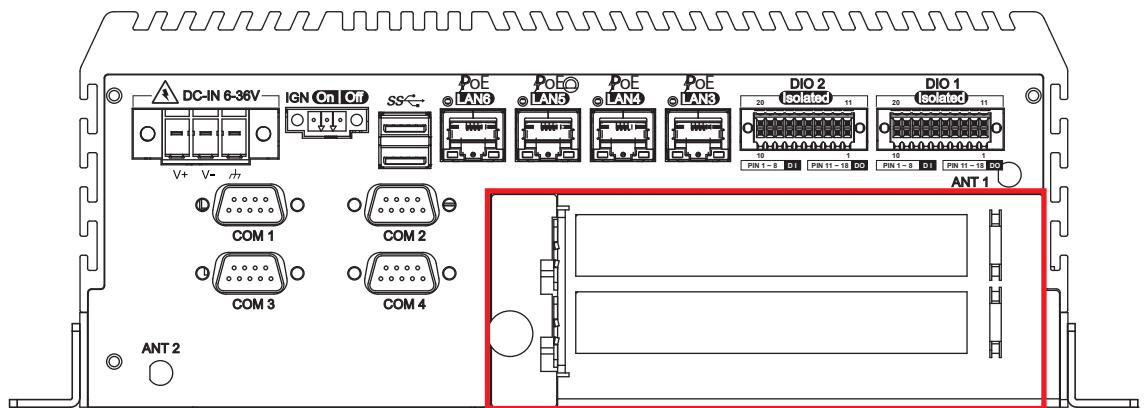

ECX-1320/1311/1302 :

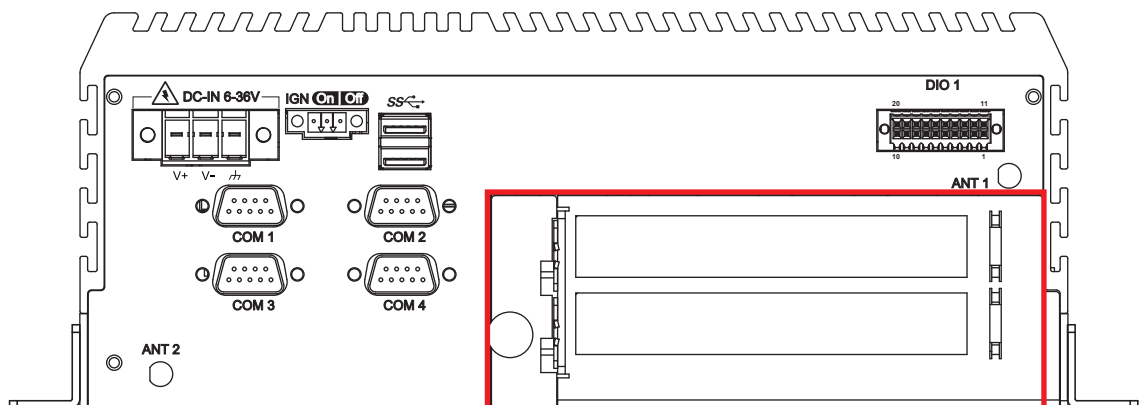

There are 2 flexible expansion feature in the rear side of ECX-1320/1311/1302/1420/1411/1402. Optional for PCIe x16, PCIe x4 FHHL add on card or PCI card.

### 2.3.7 GTX 1050 graphic card

ECX-1410/1401:

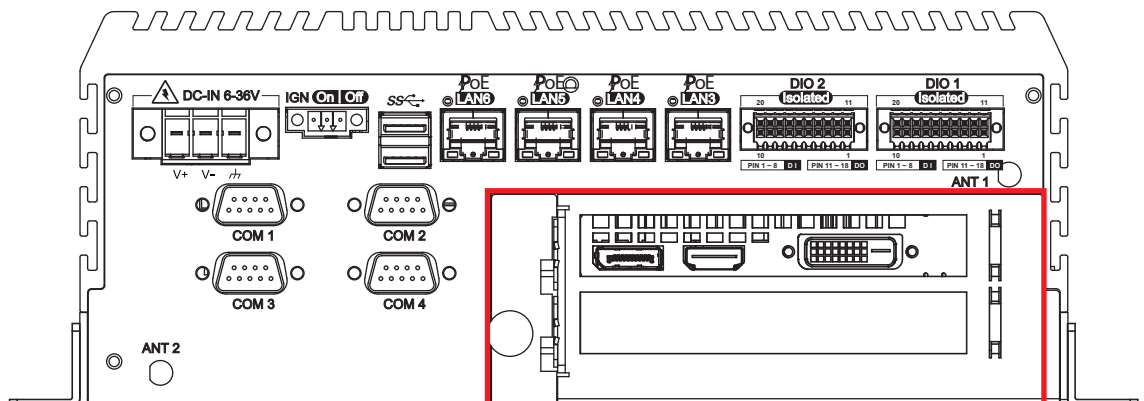

## ECX-1310/1301 :

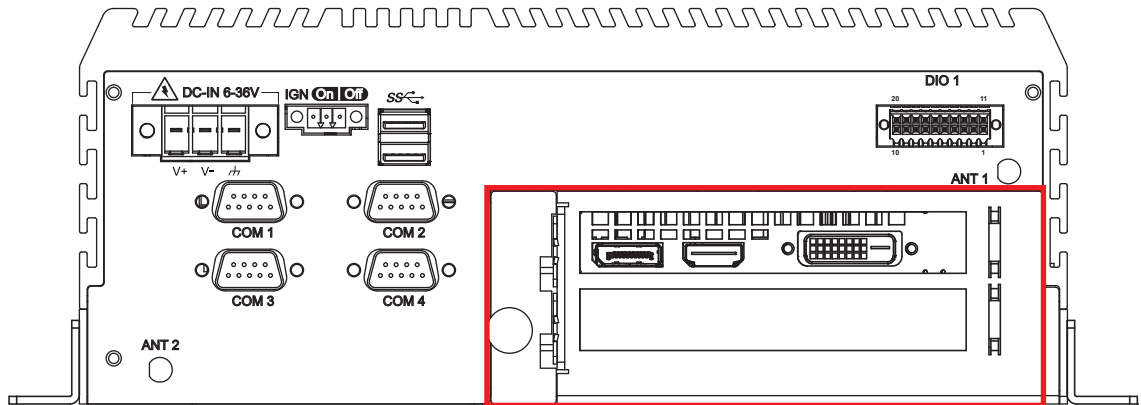

ECX-1310/1301/1410/1401 support GTX 1050 graphic card and 1 slot PCIe x4

## 2.3.8 GTX 1070 graphic card

### ECX-1400 GTX1070 :

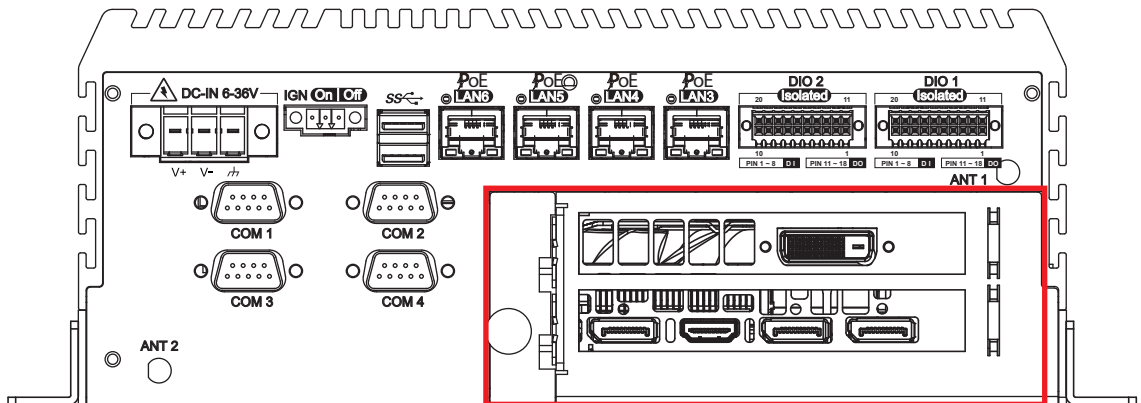

### ECX-1300 GTX1070 :

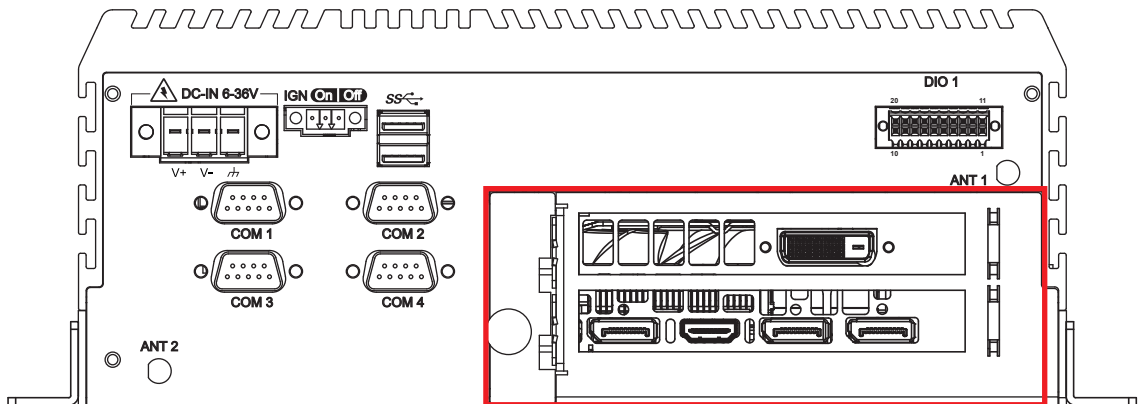

ECX-1300/1400 with GTX1070 support GTX1070 graphic card only.

## 2.4 Main Board Expansion Connectors

### 2.4.1 Top View (Component Side) of ECX-1300/1400 Main Board With Connector Location

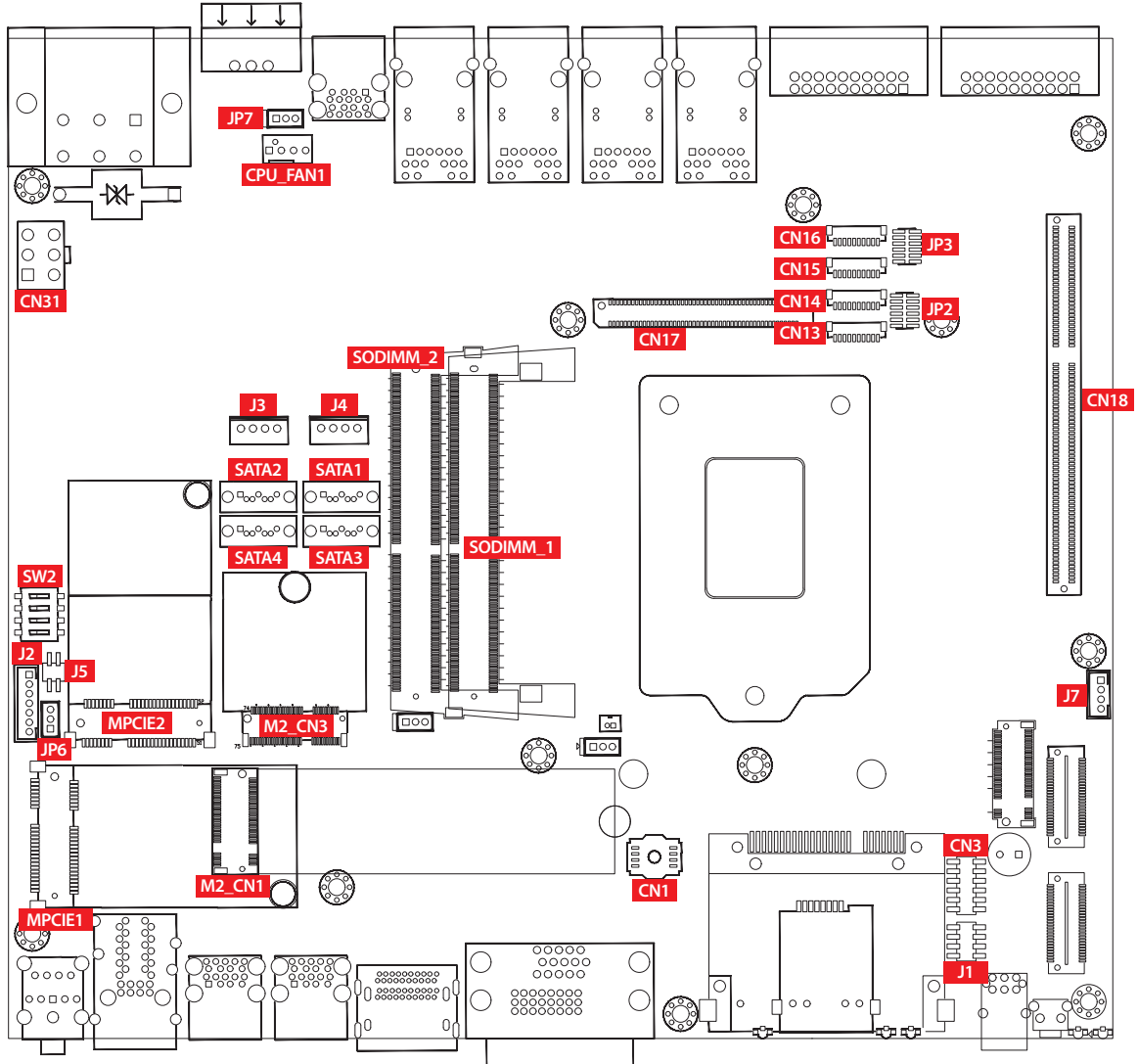

## 2.4.2 Bottom View (Solder Side) of ECX-1300/1400 Main Board With Connector Location

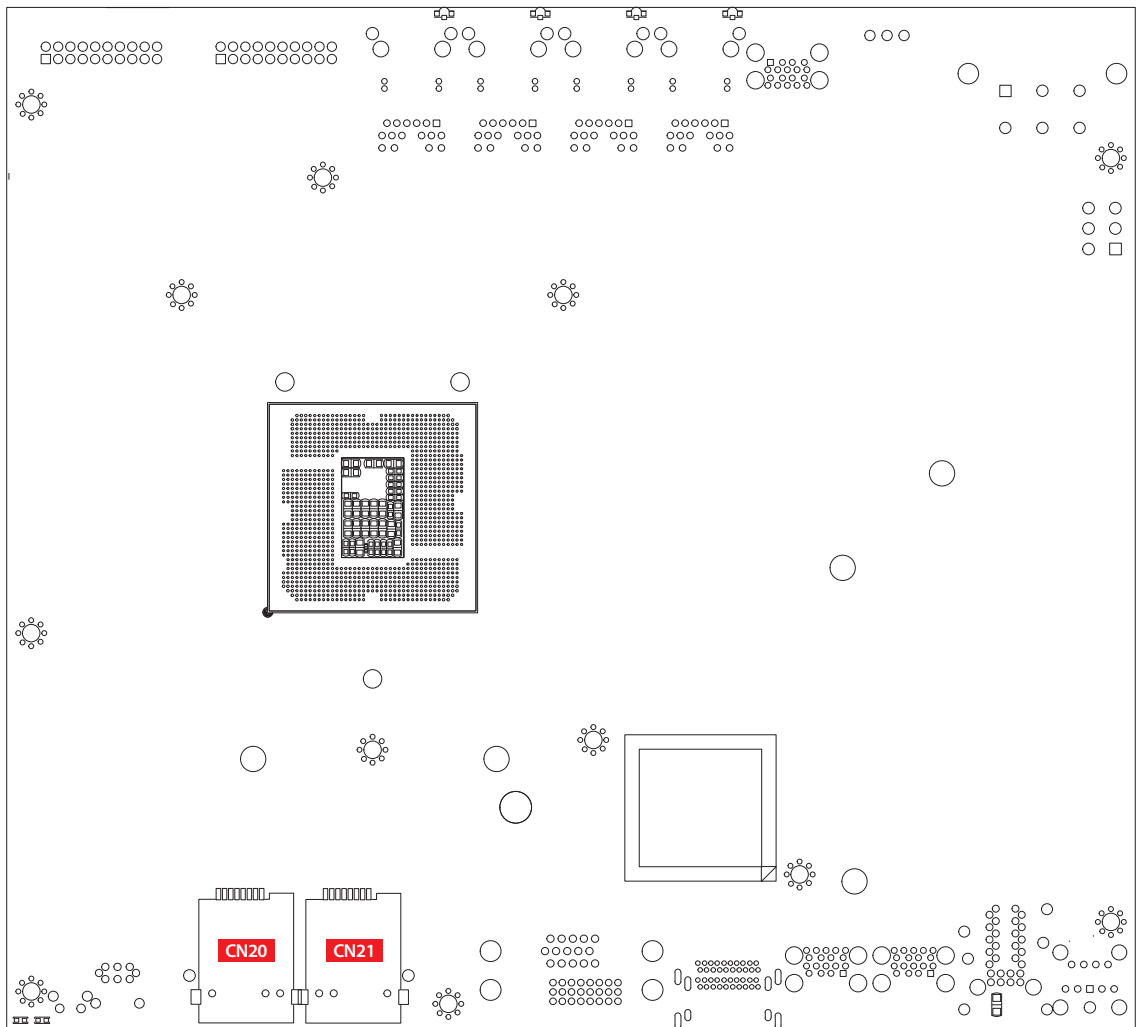

### 2.4.3 J1 : Miscellaneous Pin Header

2.0mm 2x4p header

This pin header can be used as a backup for following functions, hard drive LED indicator, reset button, power LED indicator, and power-on/off button, which already can be accessed by front panel and top panel. The pin-outs of Miscellaneous port are listed in following table :

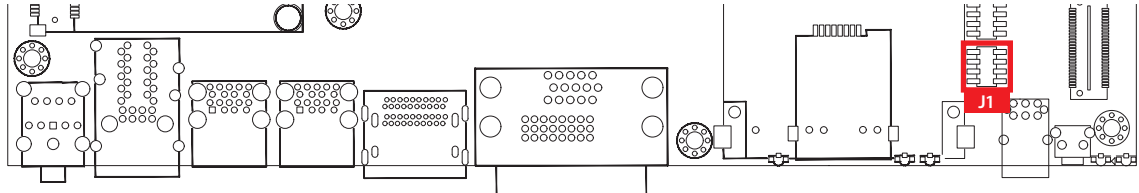

Group	Pin No.	Description
HDD LED	1	HDD_LED_P
	3	HDD_LED_N
RESET BUTTON	5	FP_RST_BTN_N
	7	Ground
POWER LED	2	PWR_LED_P
	4	PWR_LED_N
POWER BUTTON	6	FP_PWR_BTN_IN
	8	Ground

### 2.4.4 SATA1, SATA2, SATA3, SATA4 : SATA III Connector

There are 4 onboard high performance Serial ATA III (SATA III) on ECX-1300/1400. It supports higher storage capacity with less cabling effort and smaller required space. The pin assignments of SATA1 and SATA2, SATA3, SATA4 are listed in the following table :

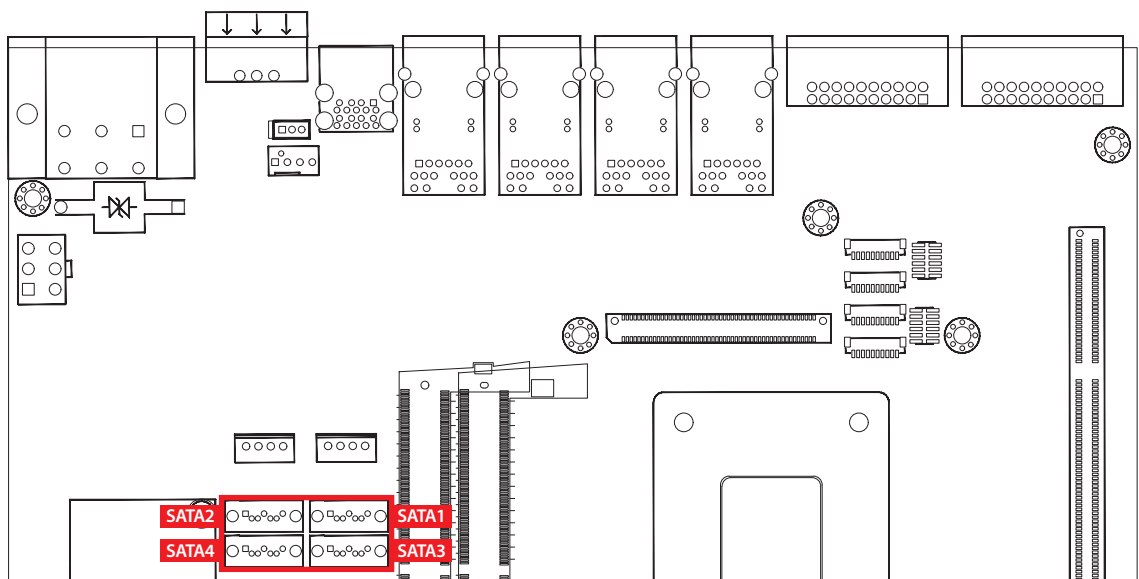

Pin No.	Definition	Pin No.	Definition
1	GND	5	RXN
2	TXP	6	RXP
3	TXN	7	GND
4	GND		

## 2.4.5 J3, J4 : SATA Power Connector

The ECX-1300/1400 also equip with a SATA power connector. The one port supports 5V (Up to 2A) and 12V (Up to 2A) current to the hard drive or SSD. The pin assignments of J3, J4 are listed in the following table :

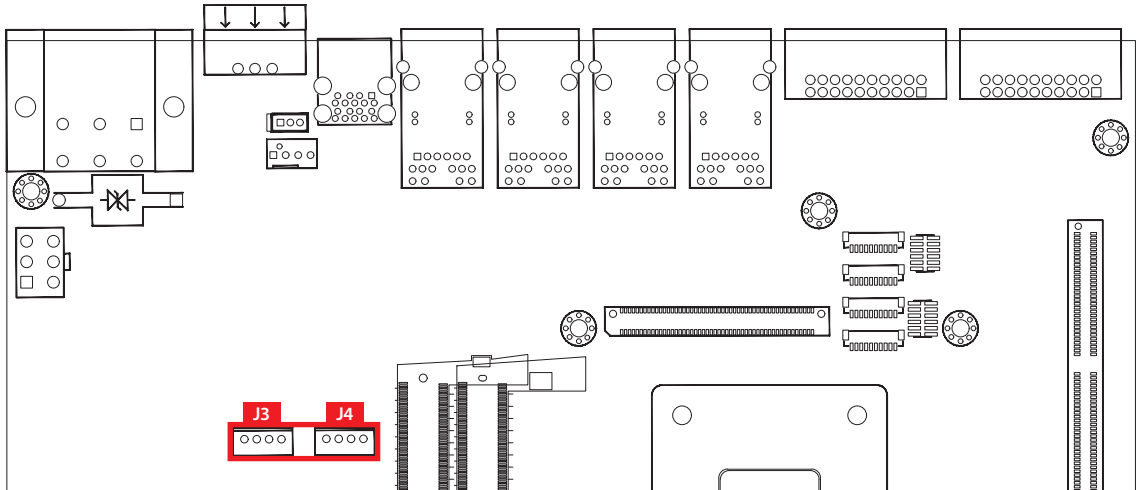

Pin No.	Definition	Pin No.	Definition
1	+12V	3	GND
2	GND	4	+5V

## 2.4.6 J7 : Internal USB

The USB 2.0 connections available supporting up to 480Mbps per second data rate. It also compliant with the requirements of SuperSpeed (SS), high speed (HS), full speed (FS) and low speed (LS). The pin assignments of J7 are listed in the following table :

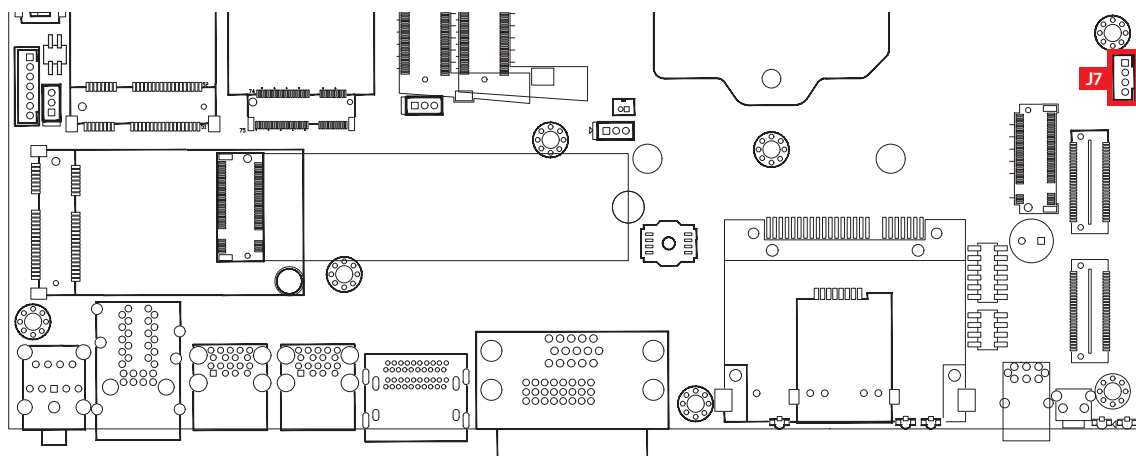

Pin No.	Description	Pin No.	Description
1	USB_VCC	3	USBD+
2	USBD-	4	GND

## 2.4.7 SODIMM\_1, SODIMM\_2 : DDR4 Slot

There are 2 DDR4 channel onboard, support DDR4 2666, max 64GB  
Each channel 32GB

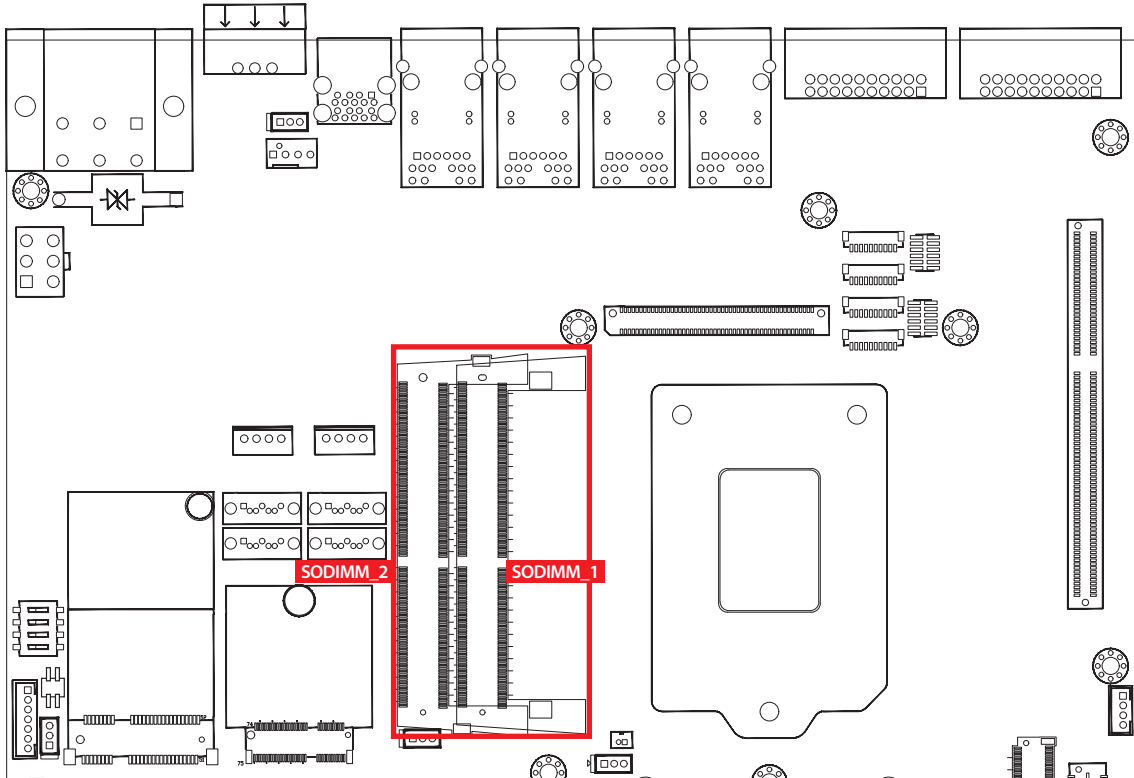

Slot	Description
SODIMM_1	DDR4 Channel A
SODIMM_2	DDR4 Channel B

## 2.4.8 CN1 : BIOS Socket

If the BIOS needs to be changed, please contact the Vecow RMA service team.

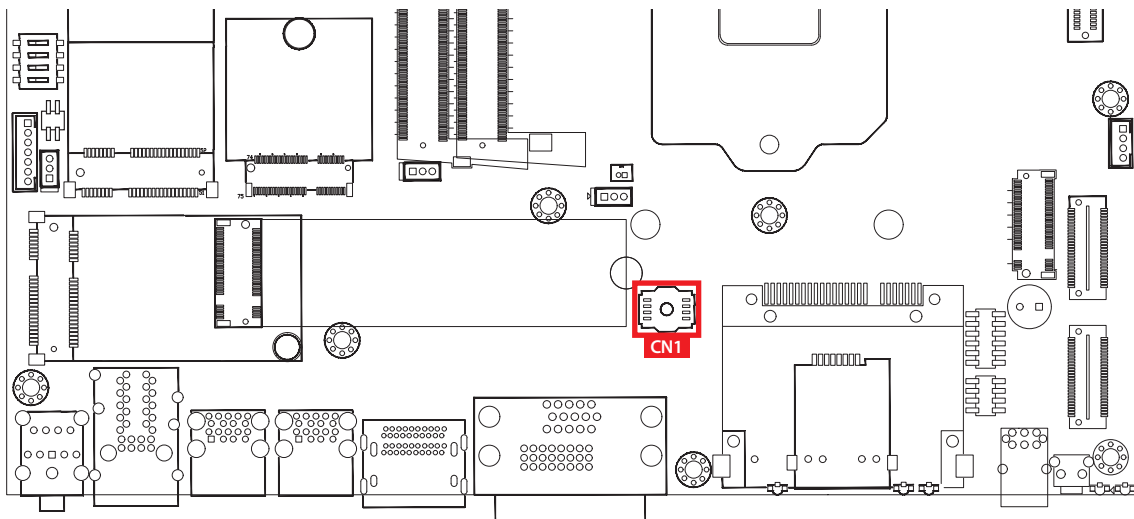



## 2.4.9 CN31 : UPS Power Connector

For UPS module optional, we use 4.2mm 3x2p power connector.

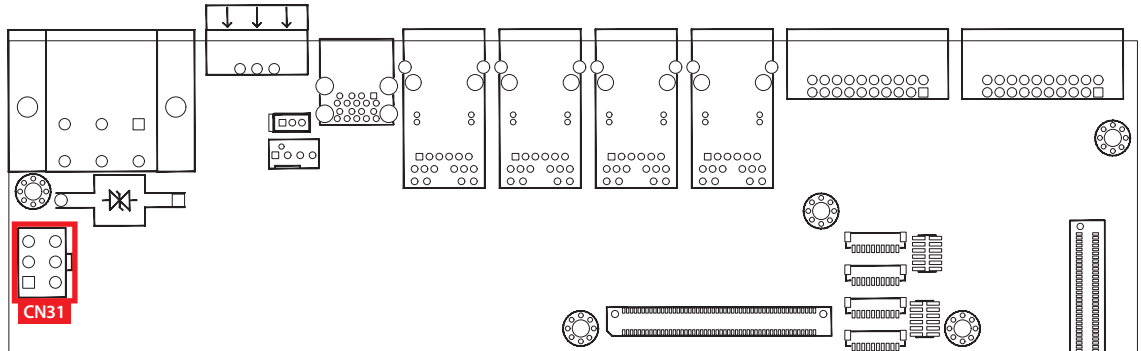

	Pin No.	Description	Pin No.	Description
	1	+VDC_IN (6~36V, Max.9A)	3	+VDC_IN (6~36V, Max.9A)
	2	+VDC_IN (6~36V, Max.9A)	4	Ground
	5	Ground	6	Ground

## 2.4.10 Mini PCIe : MPCle\_1, MPCle\_2

Standard full length mini PCIe slot

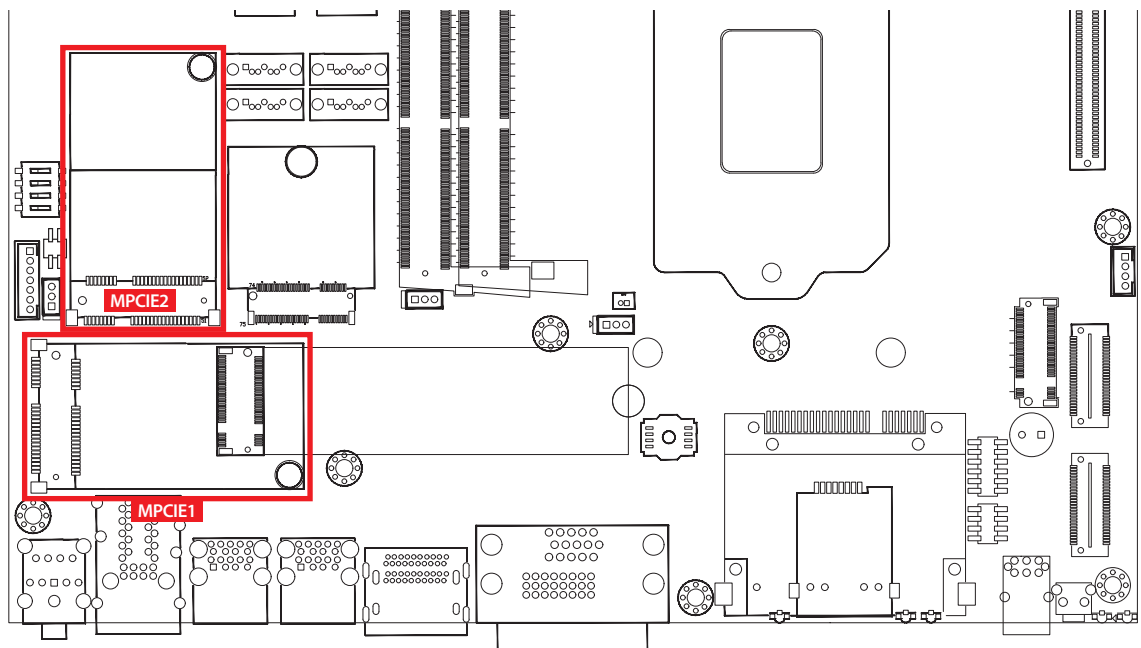

The pin assignments of Mini PCIe 1, Mini PCIe 2 ted in the following table :

Pin No.	Signal Name	Pin No.	Signal Name
51	Reserved	52	+3.3Vaux
49	Reserved	50	GND
47	Reserved	48	+1.5V
45	Reserved	46	Reserved
43	GND	44	Reserved
41	+3.3Vaux	42	Reserved
39	+3.3Vaux	40	GND
37	GND	38	USB_D+
35	GND	36	USB_D-
33	PETp0	34	GND
31	PETn0	32	SMB_DATA
29	GND	30	SMB_CLK
27	GND	28	+1.5V
25	PERp0	26	GND
23	PERn0	24	+3.3Vaux
21	GND	22	PERST#
19	Reserved	20	reserved
17	Reserved	18	GND
Mechanical Key			
15	GND	16	UIM_VPP
13	REFCLK+	14	UIM_RESET
11	REFCLK-	12	UIM_CLK
9	GND	10	UIM_DATA
7	CLKREQ#	8	UIM_PWR
5	Reserved	6	1.5V
3	Reserved	4	GND
1	WAKE#	2	3.3Vaux

## 2.4.11 BAT1 : RTC Battery

The system's real-time clock is powered by a lithium battery. It is Equipped with Panasonic BR2032 190mAh lithium battery. It is recommended that you not replace the lithium battery on your own. If the battery needs to be changed, please contact the Vecow RMA service team.

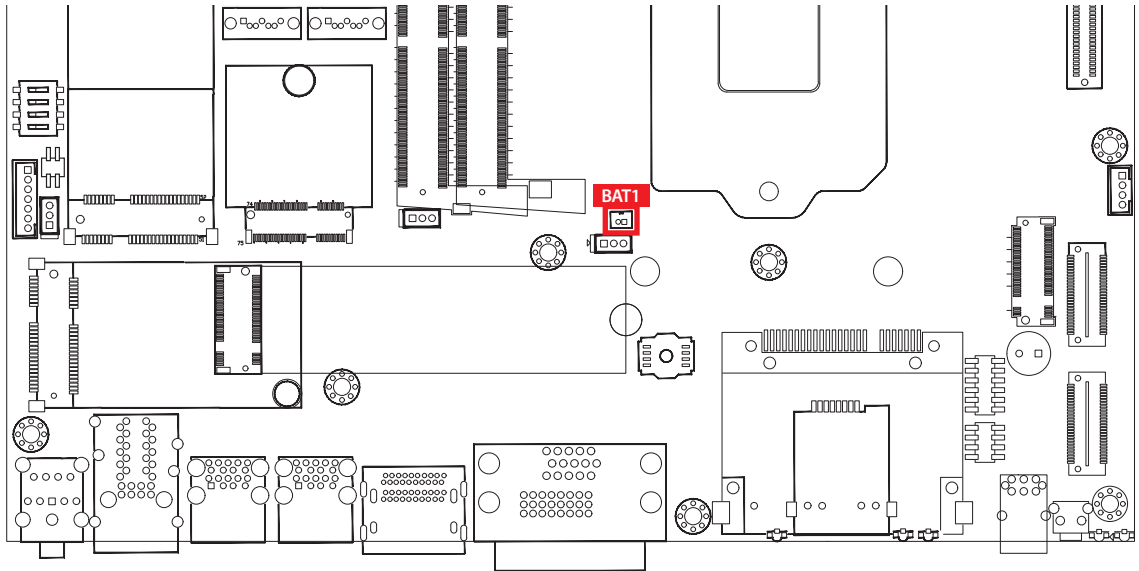

## 2.4.12 CPU\_FAN1 : FAN Header

Fan power connector supports for additional thermal requirements. The pin assignments of CPU\_FAN1 are listed in the following table.

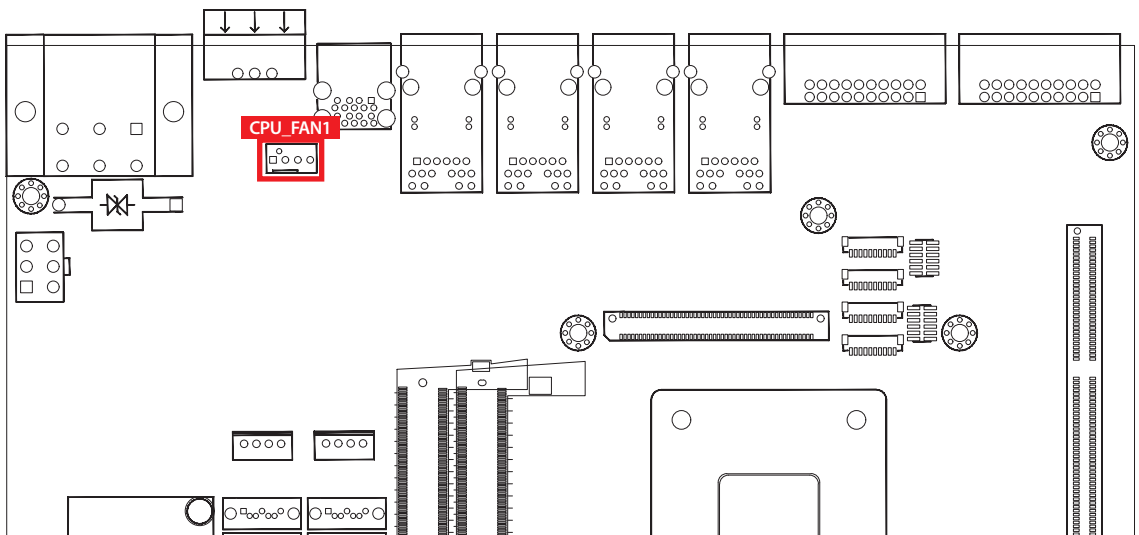

	Pin No.	Definition	Pin No.	Definition
	1	GND	3	Fan speed sensor
	2	+12V (1.5A max)	4	Fan PWM

### 2.4.13 CN3 : LPC Port 80 Header

The system's provide a LPC Port 80 Header for Debug Card.

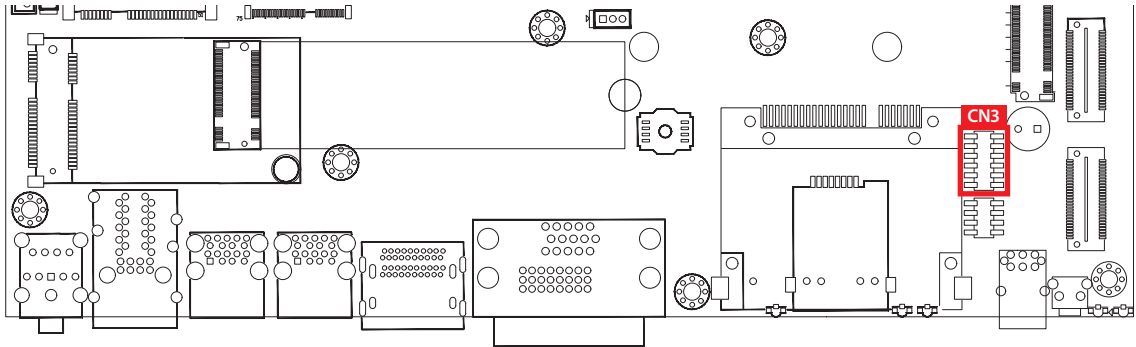

Pin No.	Definition	Pin No.	Definition
1	SERIRQ	7	LFRAME#
2	+3.3V	8	LAD0
3	LA3	9	N/C
4	RESET#	10	Ground
5	LAD1	11	CLOCK
6	LAD2	12	Ground

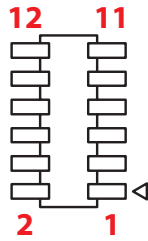

### 2.4.14 M2\_CN1, M2\_CN3 : M.2 slot

2280 length and 2230 length M.2 slot

The pin assignments of M2\_CN1, M2\_CN3 in the following table :

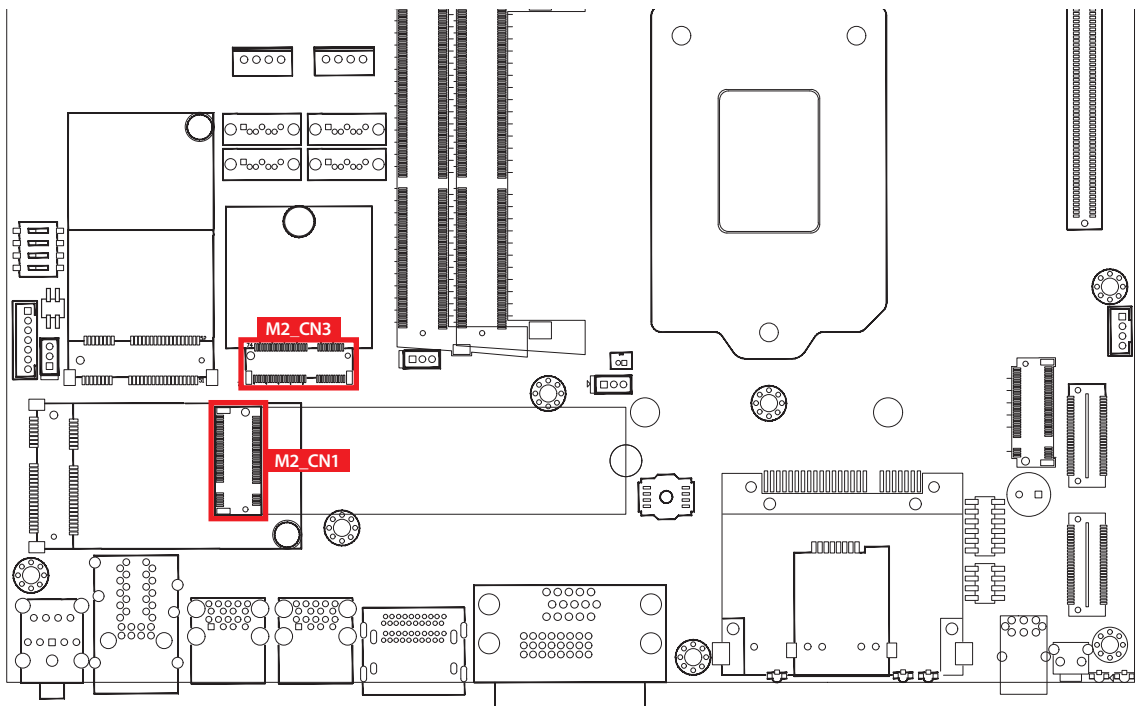

M2\_CN1 : M.2 KEY B (Dimension : 2280)

Pin No.	Signal Name	Pin No.	Signal Name
		80	Ground
75	NC		
73	Ground	74	3.3V
71	Ground	72	3.3V
69	CONFIG_1	70	3.3V
67	NC	68	NC
65	NC	66	SIM DETECT
63	NC	64	NC
61	NC	62	NC
59	NC	60	NC
57	Ground	58	NC
55	REFCLKp	56	NC
53	REFCLKn	54	PEWAKE#
51	Ground	52	CLKREQ#
49	PETn0/SATA-A+	50	PERST#
47	PETn0/SATA-A-	48	NC
45	Ground	46	NC
43	PERn0/SATA-B-	44	NC
41	PERn0/SATA-B+	42	NC
39	Ground	40	NC
37	NC	38	DEVSLP
35	NC	36	UIM-PWR
33	Ground	34	UIM-DATA
31	NC	32	UIM-CLK
29	NC	30	UIM-RESET
27	Ground	28	NC
25	NC	26	NC
23	NC	24	NC
21	NC	22	NC
		20	NC
Mechanical Key			
11	Ground		
9	USB-	10	LED_1#
7	USB+	8	W_DISABLE1
5	Ground	6	FULL_CARD_PWR_OFF/ ON
3	Ground	4	3.3V
1	NC	2	3.3V

M2\_CN3 : M.2 KEY E (Dimension : 2230)

Pin No.	Signal Name	Pin No.	Signal Name
75	Ground		
73	NC	74	3.3V
71	NC	72	3.3V
69	Ground	70	PEWAKE1#
67	NC	68	NC
65	NC	66	NC
63	Ground	64	NC
61	NC	62	ALERT
59	NC	60	I2C_CLK
57	Ground	58	I2C_DATA
55	PEWAKE0#	56	NC
53	CLKREQ0#	54	NC
51	Ground	52	PERST0#
49	REFCLKn0	50	NC
47	REFCLKp0	48	NC
45	Ground	46	NC
43	PERn0	44	NC
41	PERp0	42	NC
39	Ground	40	NC
37	PETn0	38	DEVSLP
35	PETp0	36	NC
33	Ground	34	NC
		32	NC
Mechanical Key			
23	NC		
21	NC	22	NC
19	Ground	20	NC
17	NC	18	Ground
15	NC	16	NC
13	Ground	14	NC
11	NC	12	NC
9	NC	10	NC
7	Ground	8	NC
5	USB-	6	LED1#
3	USB+	4	3.3V
1	Ground	2	3.3V

## 2.5 Main Board Jumper Settings

### 2.5.1 Board top view of the system main board with jumper and DIP switch

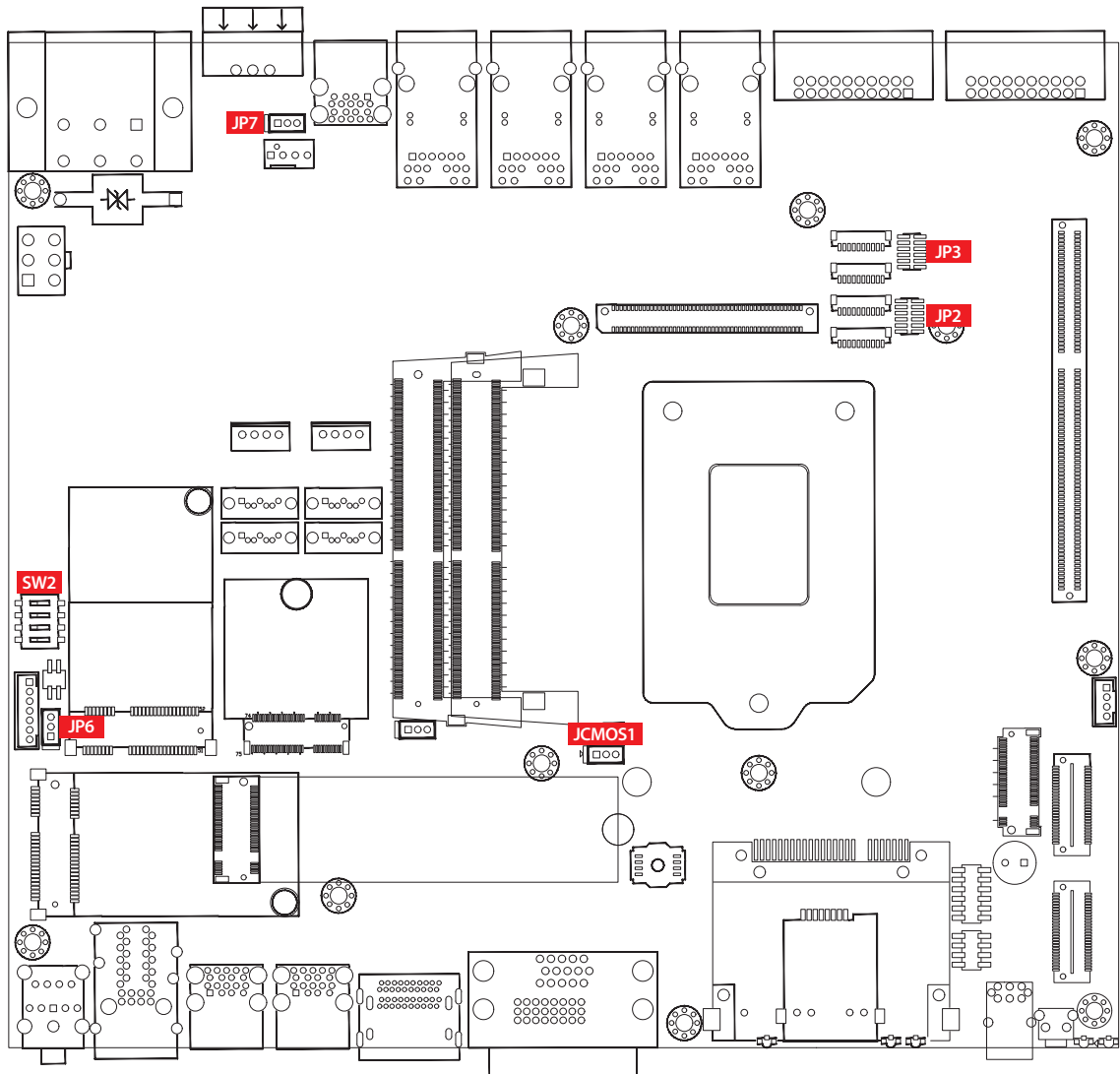

The figure below is the top view of the system main board which is the main board. It shows the location of the jumpers and the switches.

You may configure your card to match the needs of your application by setting jumpers. A jumper is a metal bridge used to close an electric circuit. It consists of two metal pins and a small metal clip (often protected by a plastic cover) that slides over the pins to connect them. To "close" a jumper, you connect the pins with the clip. To "open" a jumper, you remove the clip. Sometimes a jumper will have three pins, labeled 1, 2 and 3. In this case you would connect either pins 1 and 2, or 2 and 3.

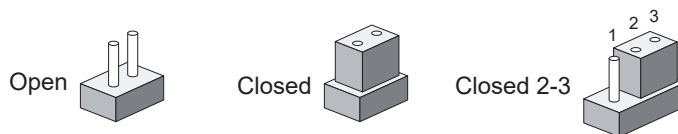

You may configure your card to match the needs of your application by DIP switch. As below show the DIP switch on and off.

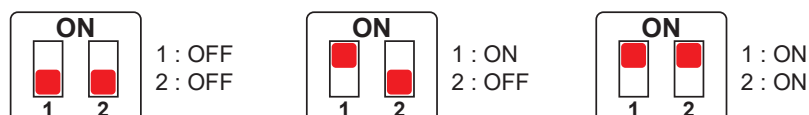

## 2.5.2 JP6 : USB Wake Up

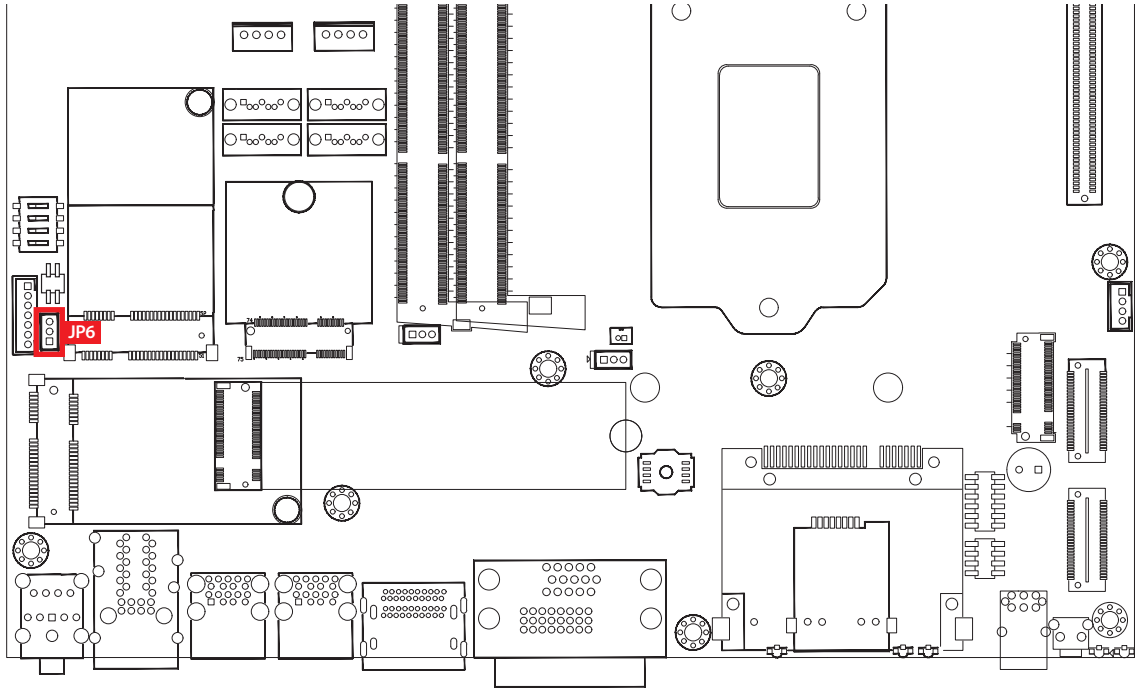

Jumper	Setting	Function
JP6	2 : 3	Non Wake Up support
JP6	1 : 2	Supported Wake Up (Default)

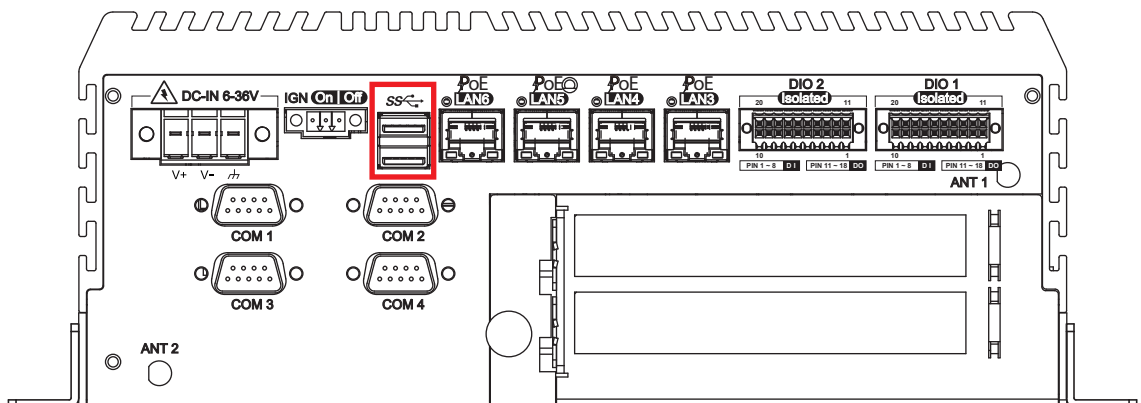
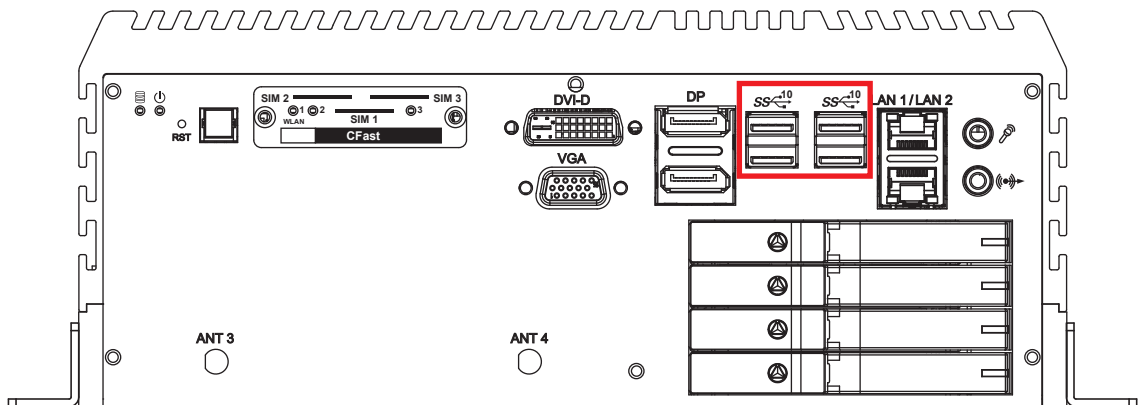



### 2.5.3 JP2, JP3 : COM Port RI pin Select

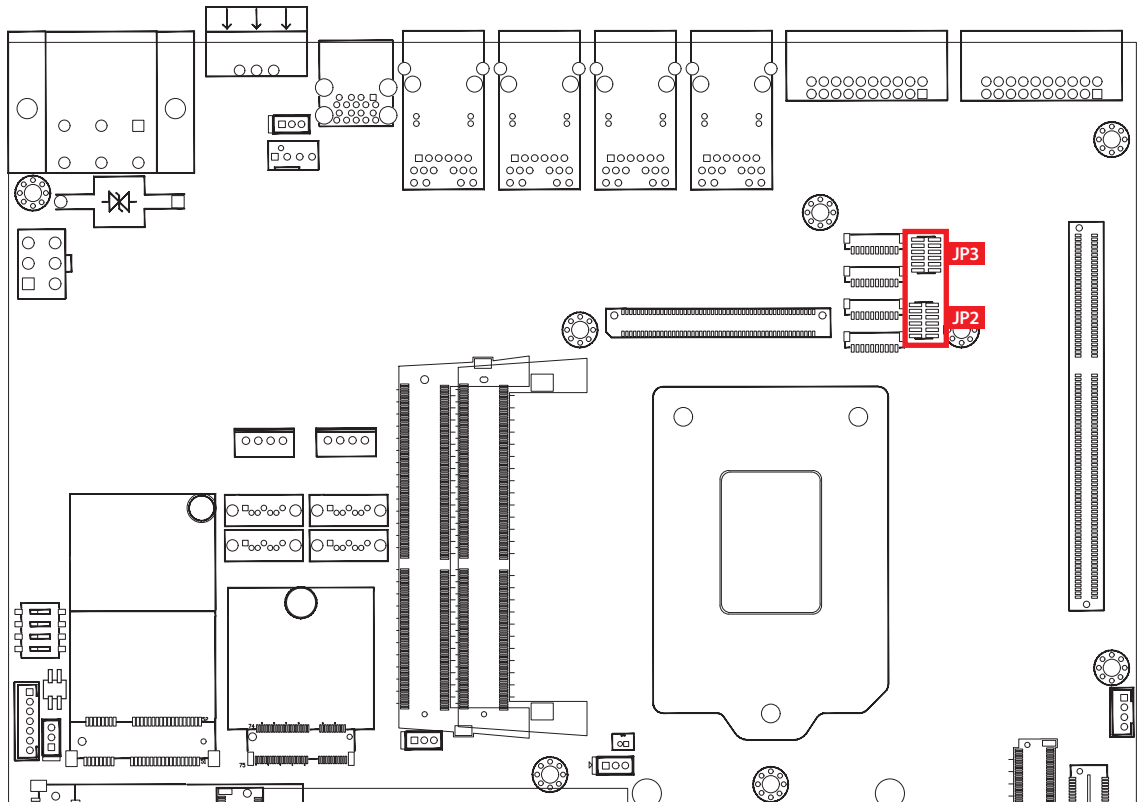

Pin Header	Pin No.	Description
COM1 to COM2 JP2	1 - 2	+5V (1A max.)
	3 - 4	+12V (0.5A max.)
	5 - 6	RI (Default)
	7 - 8	+5V (1A max.)
	9 - 10	+12V (0.5A max.)
	11 - 12	RI (Default)

Pin Header	Pin No.	Description
COM3 to COM4 JP3	1 - 2	+5V (1A max.)
	3 - 4	+12V (0.5A max.)
	5 - 6	RI (Default)
	7 - 8	+5V (1A max.)
	9 - 10	+12V (0.5A max.)
	11 - 12	RI (Default)

## 2.5.4 JP7 : PoE Power ON Select

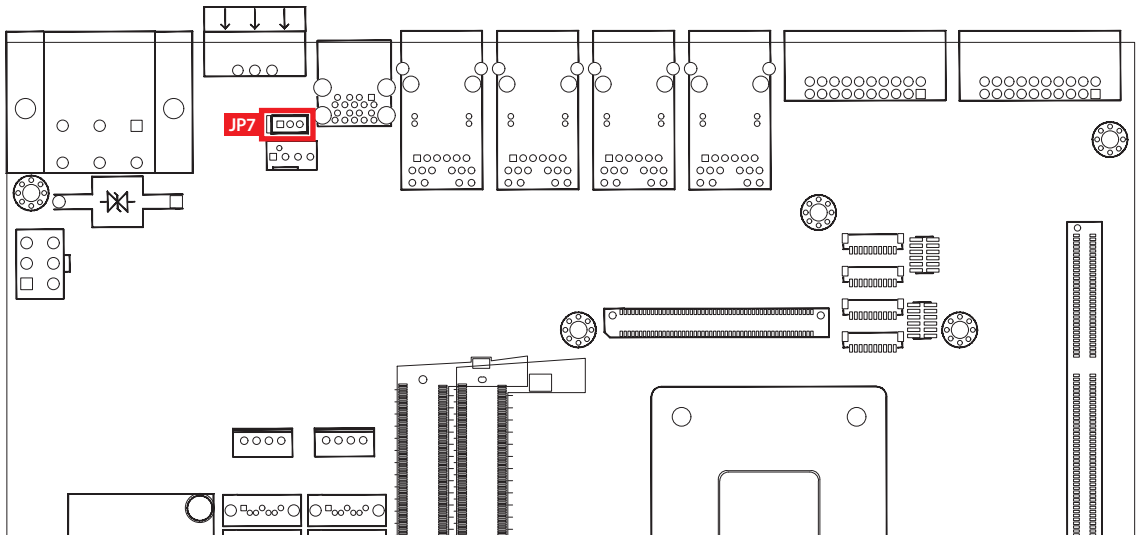

Jumper	Setting	Function
JP7	1 : 2	PoE power on at standby power ready
JP7	2 : 3	PoE power on after system power on (Default)
JP7	No Jumper	Disable PoE power

## 2.5.5 JCMOS1 : CMOS

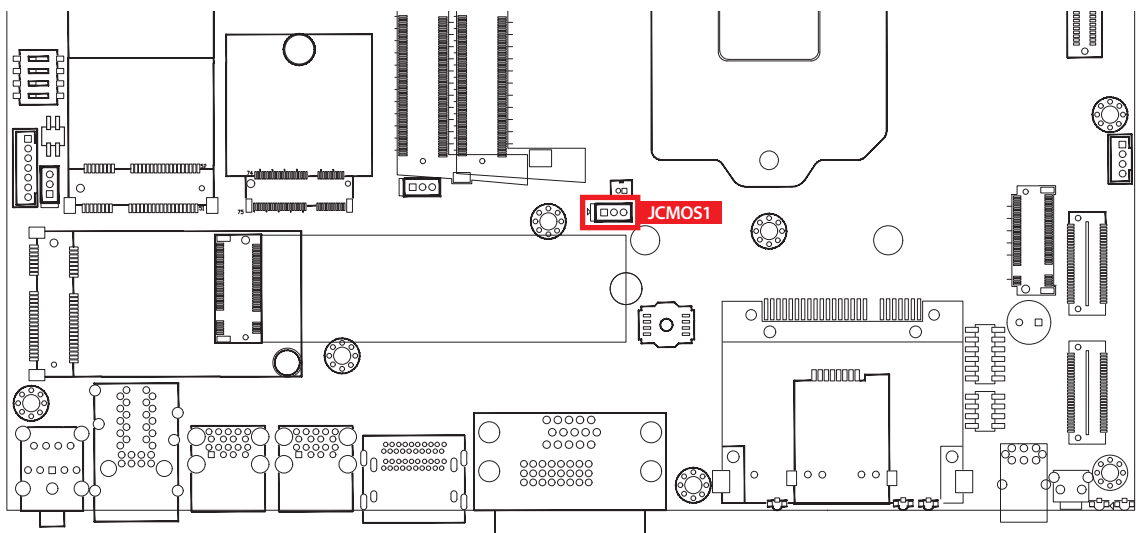

Jumper	Setting	Function
JCMOS1	1 : 2	*Normal (Default)
JCMOS1	2 : 3	Clear CMOS

## 2.6 Ignition Control





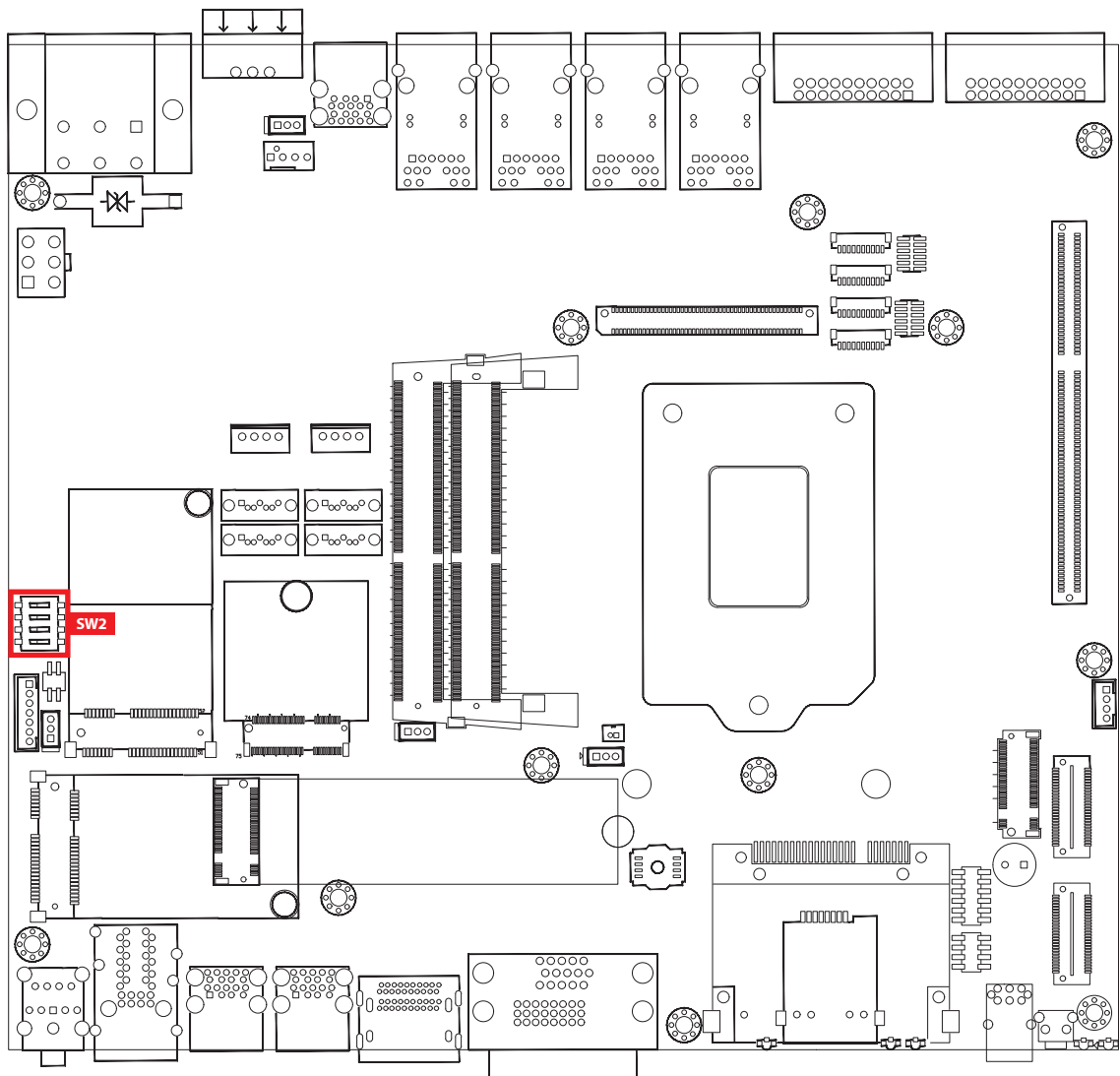

ECX-1300/1400 series provides ignition power control feature for in-vehicle applications. The built-in MCU monitors the ignition signal and turns on/off the system according to pre-defined on/off delay period.

### 2.6.1 Adjust Ignition Control Modes

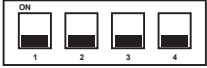
ECX-1300/1400 series provides 16 modes of different power on/off delay periods adjustable via SW2 switch. The default rotary switch is set to 0 in ATX/AT power mode.

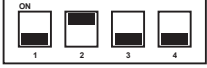
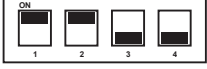
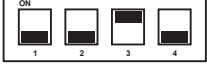
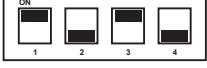
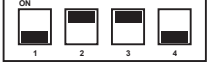
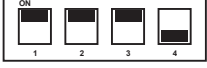

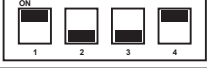
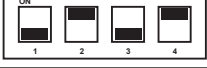
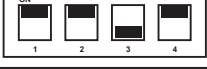
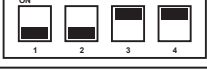
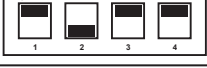
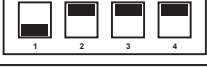
The modes are listed in below table :

DIP Switch Position	Power on delay	Power off delay	Switch Position
0	ATX/AT mode (Default)		
1	No delay	No delay	
2	No delay	5 seconds	
3	No delay	10 seconds	
4	No delay	20 seconds	
5	5 seconds	30 seconds	
6	5 seconds	60 seconds	
7	5 seconds	90 seconds	
8	5 seconds	30 minutes	
9	5 seconds	1 hour	
A	10 seconds	2 hours	
B	10 seconds	4 hours	
C	10 seconds	6 hours	
D	10 seconds	8 hours	
E	10 seconds	12 hours	
F	10 seconds	24 hours	

## 2.6.2 Ignition Control Wiring

To activate ignition control, you need to provide IGN signal via the 3-pin pluggable terminal block locates in the back panel. Please find below the general wiring configuration.

Pin No.	Definition
1	Ignition (IGN)
2	SW+
3	SW-

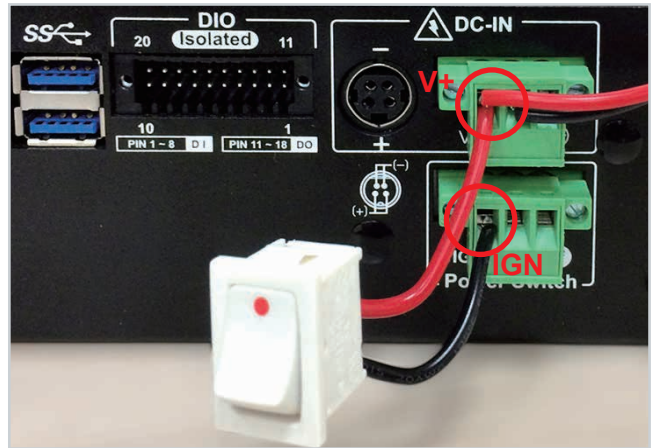

For testing purpose, you can refer to the picture blow to simulate ignition signal input controlled by a latching switch.

Note :

1. DC power source and IGN share the same ground.
2. ECX-1400/1300 supports 6V to 36V wide range DC power input in ATX/AT mode. In Ignition mode, the input voltage is fixed to 12V/24V for car battery scenario.
3. For proper ignition control, the power button setting should be "Power Down" mode.

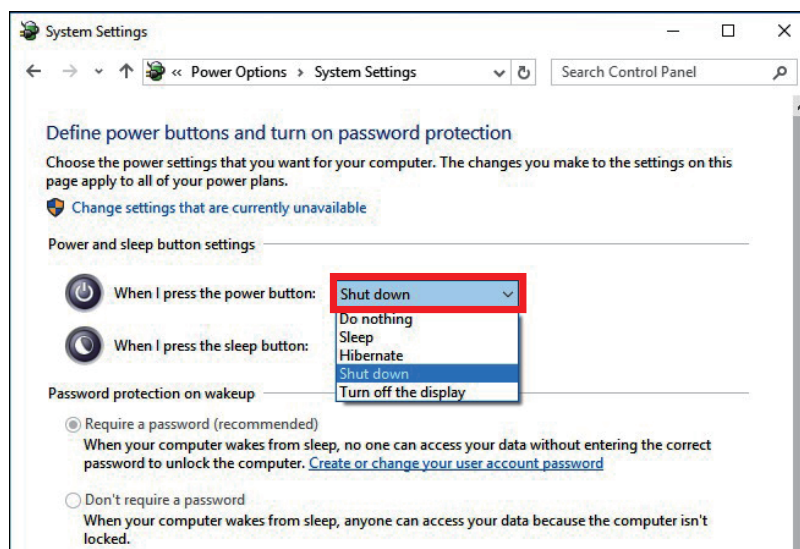

In Windows for example, you need to set "When I press the power button" to Shut down.

# 3

## SYSTEM SETUP

### 3.1 How to Open Your ECX-1400/1300

**Step 1** Remove six PHILLIPS#6-32 screws.

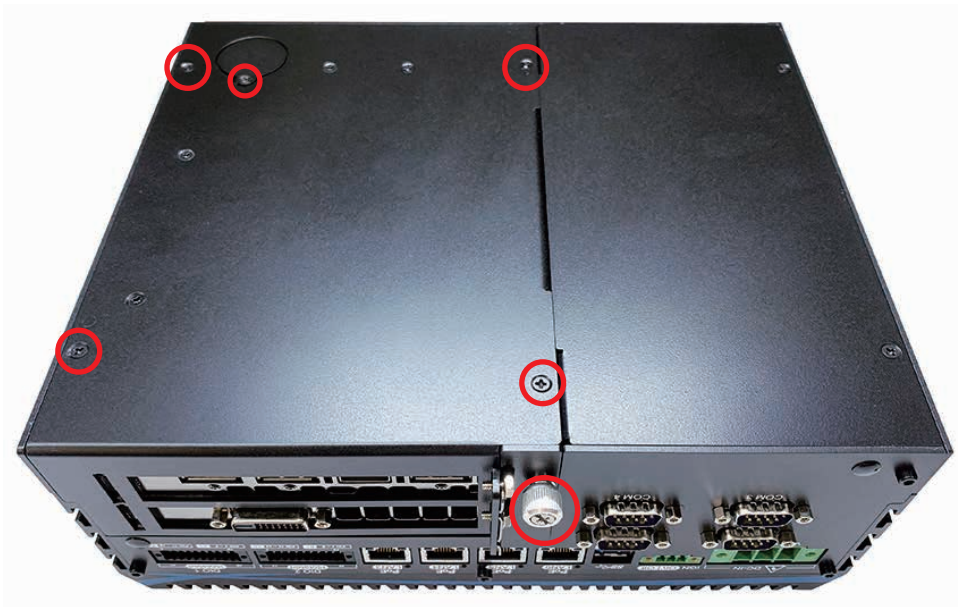

**Step 2** Take off the PCI/PCIe tray.

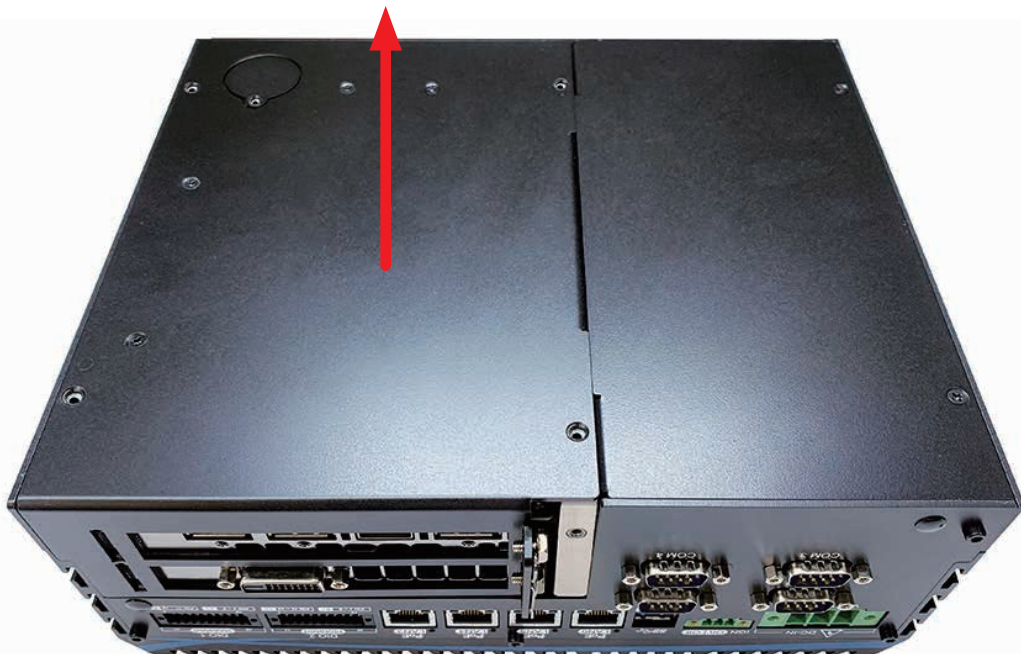

**Step 3** Remove two PHILLIPS#6-32 screws.



**Step 4** Turn over ECX-1300/1400 to face the front side.



**Step 5** Remove one HEX#6-32 screw.



**Step 6** Take out SSD/HDD tray module.





**Step 7** Finish.



## 3.2 Installing CPU

**Step 1** Remove SATA DATA, SATA Power and COM cable.

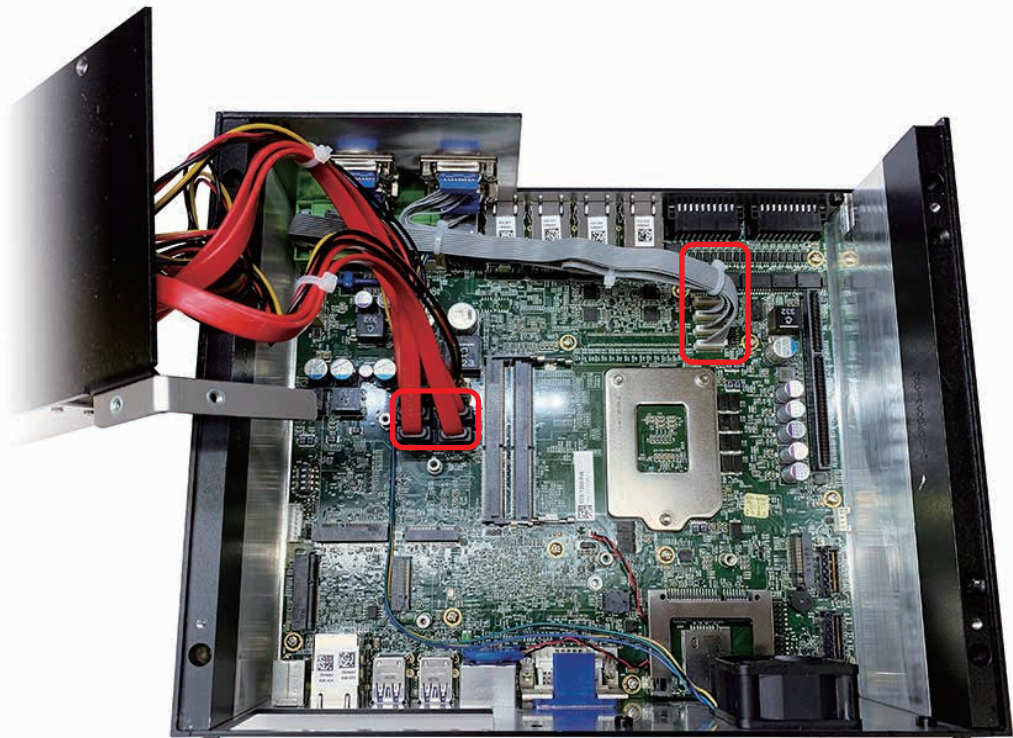

**Step 2** Remove FAN cable. (ECX-1400/1300 GTX series)

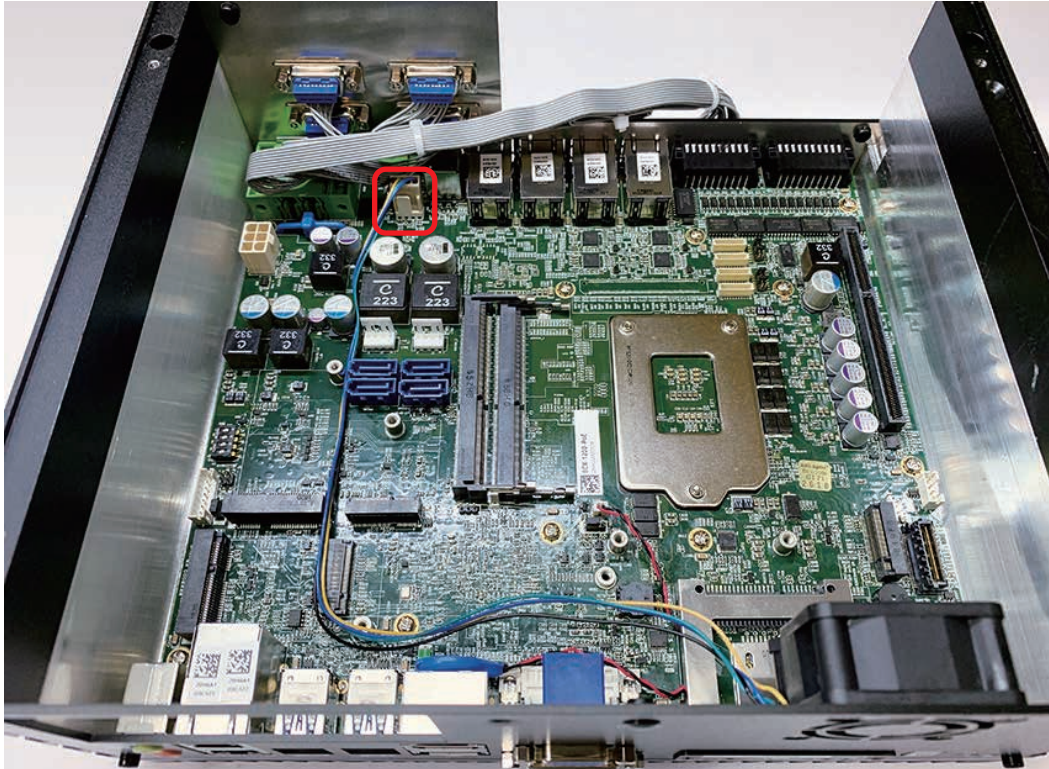

**Step 3** Remove five HEX#6-32 and four HEX#4-40 screws.



**Step 4** Remove front panel and turn over to face the rear side.

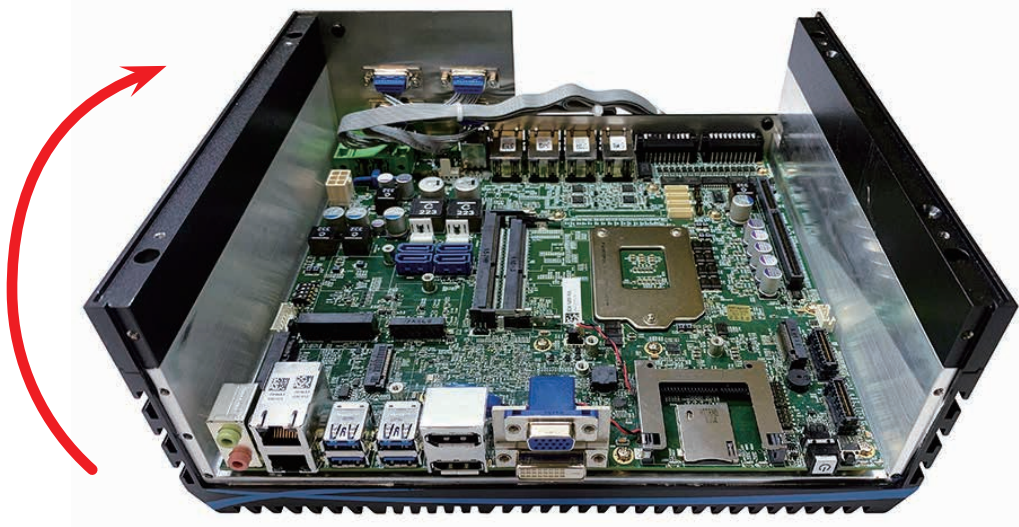

**Step 5** Remove four HEX#6-32 screws.

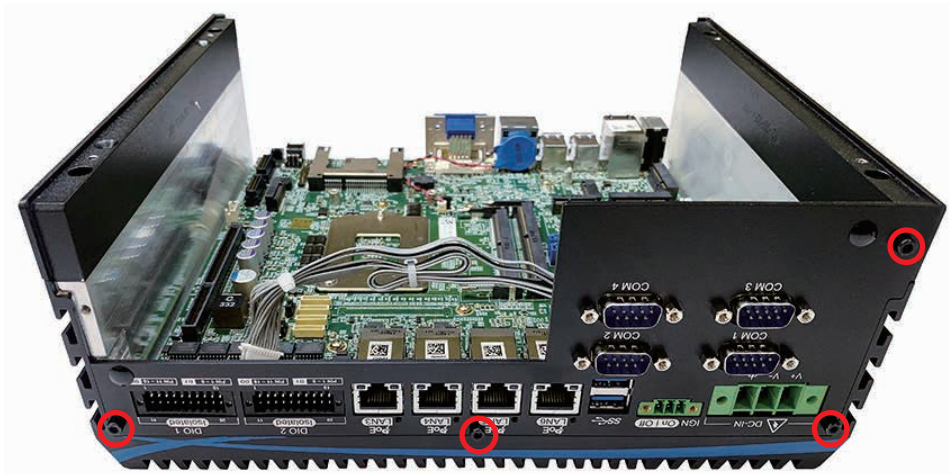

**Step 6** Remove four HEX#6-32 screws.

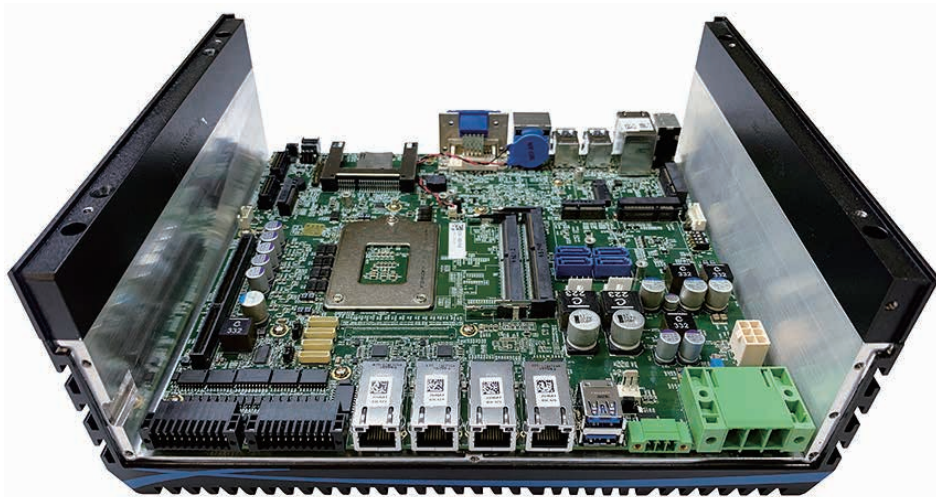

**Step 7** Remove twelve PHILLIPS M3 screws and take out main board from the heat sink.

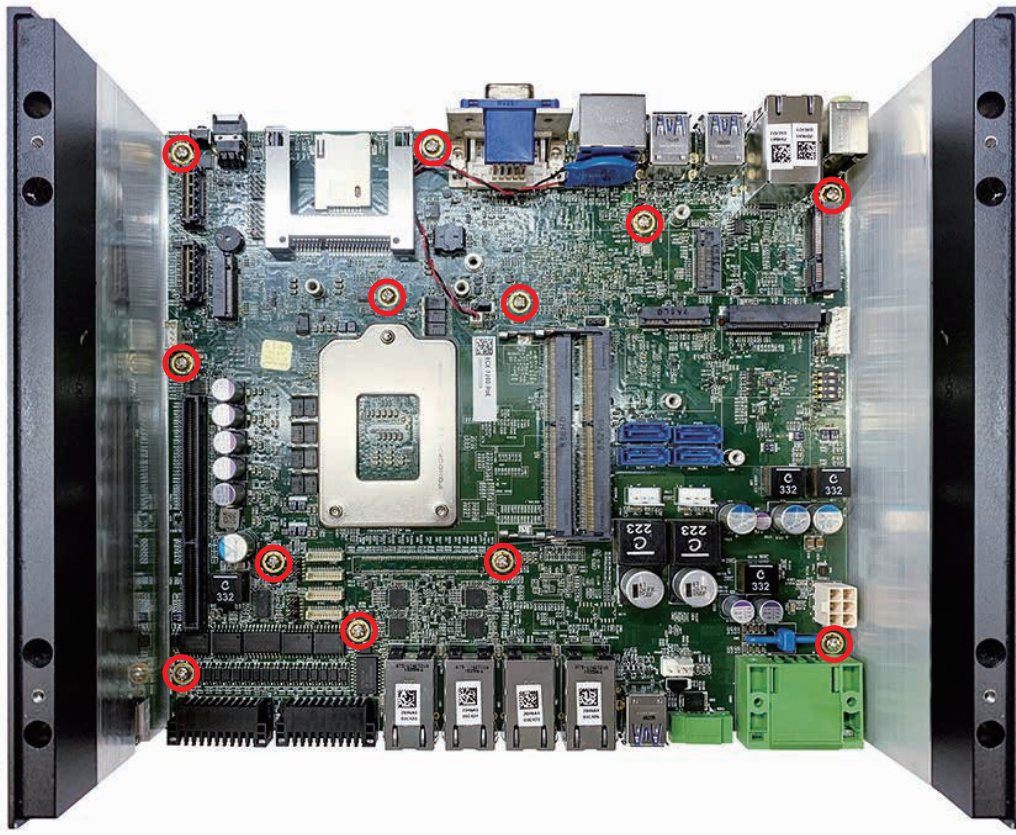

**Step 8** Turn over the main board to make the CPU socket side up.

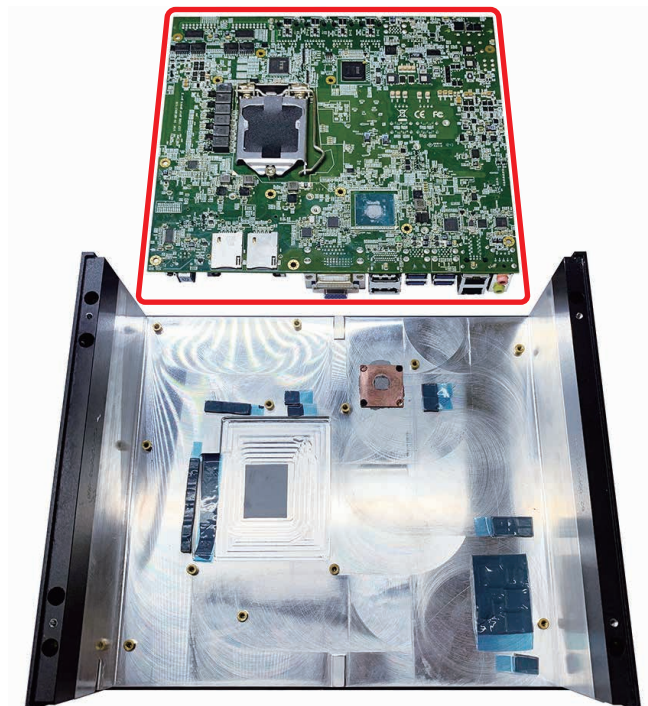

**Step 9** Unlock the CPU socket.

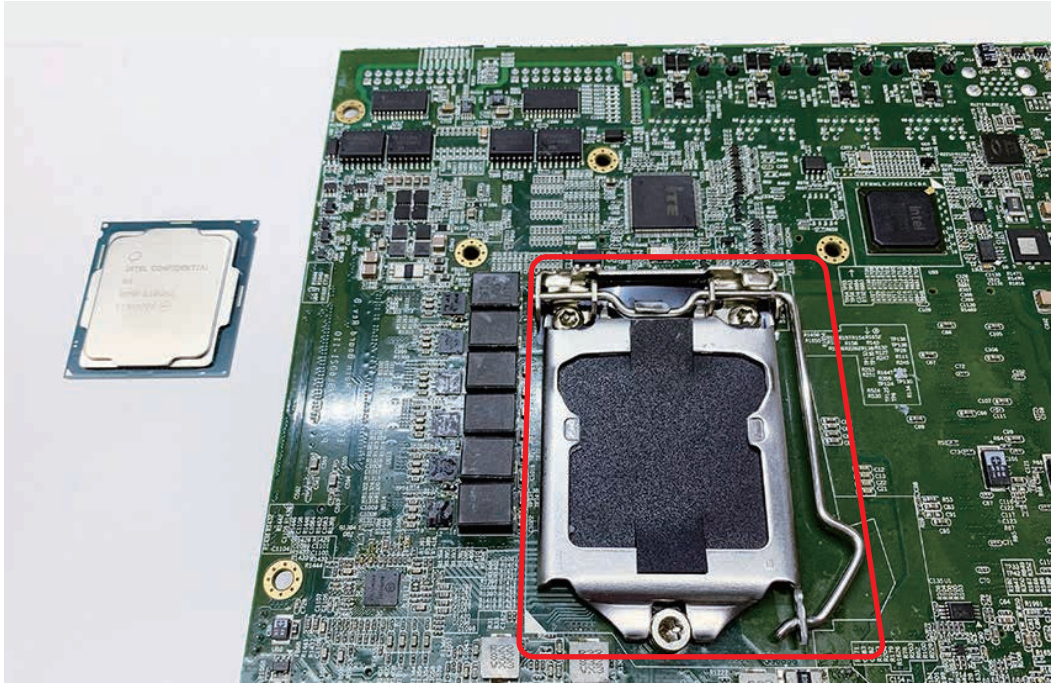

**Step 10** Open the CPU socket cover.

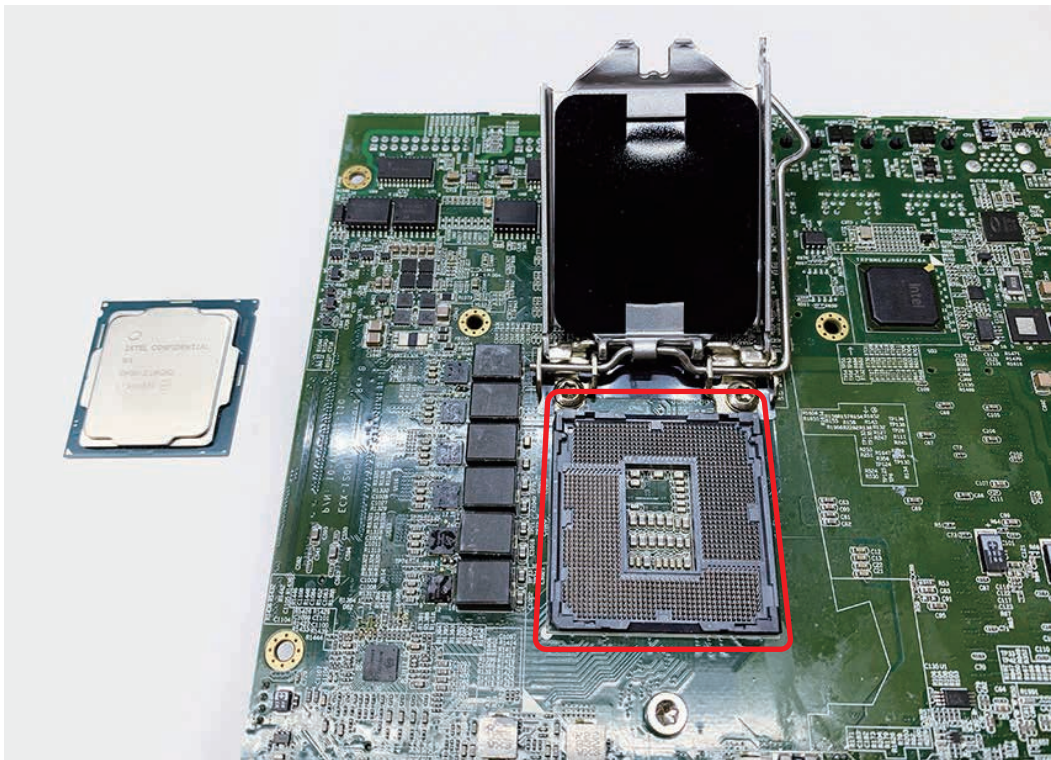

**Step 11** Watch out the direction of CPU and put CPU into the CPU socket.

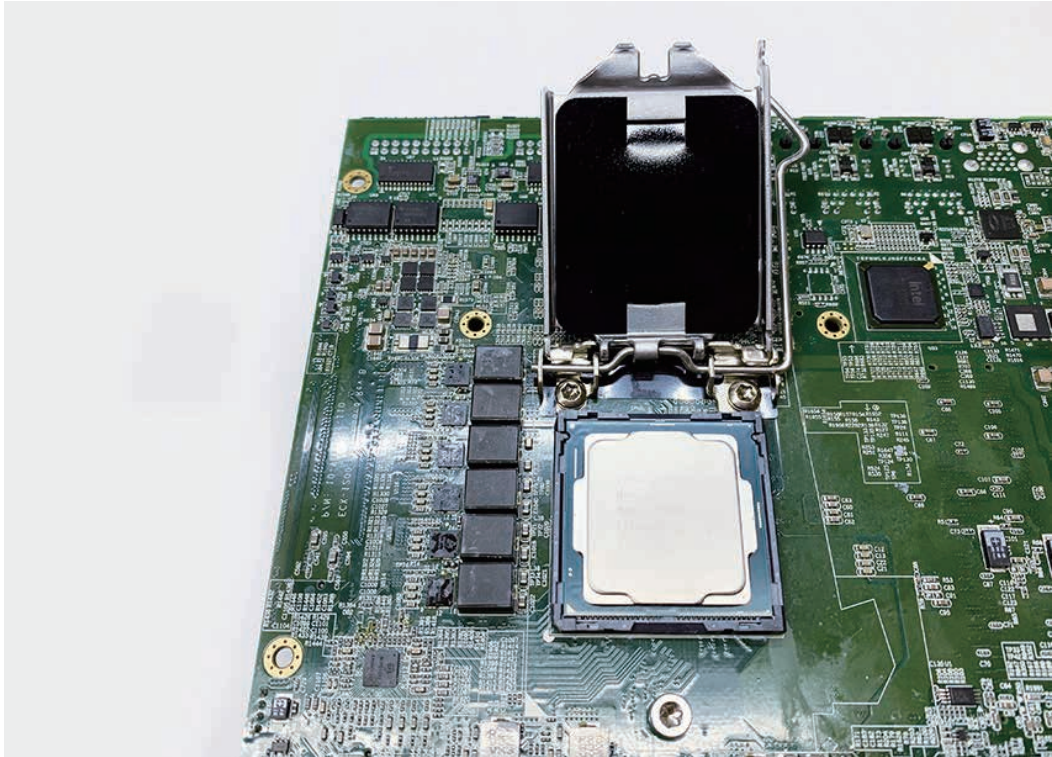

**Step 12** Remove the mylar from CPU cover and lock the cover.

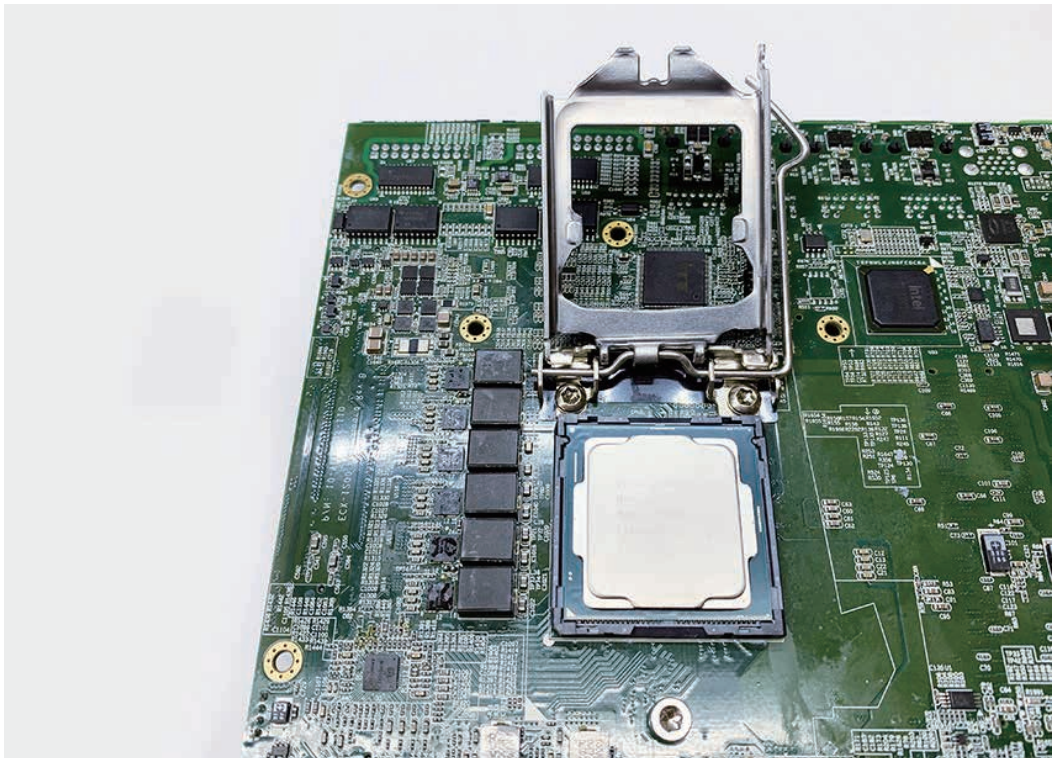

**Step 13** Cover and lock the CPU socket.

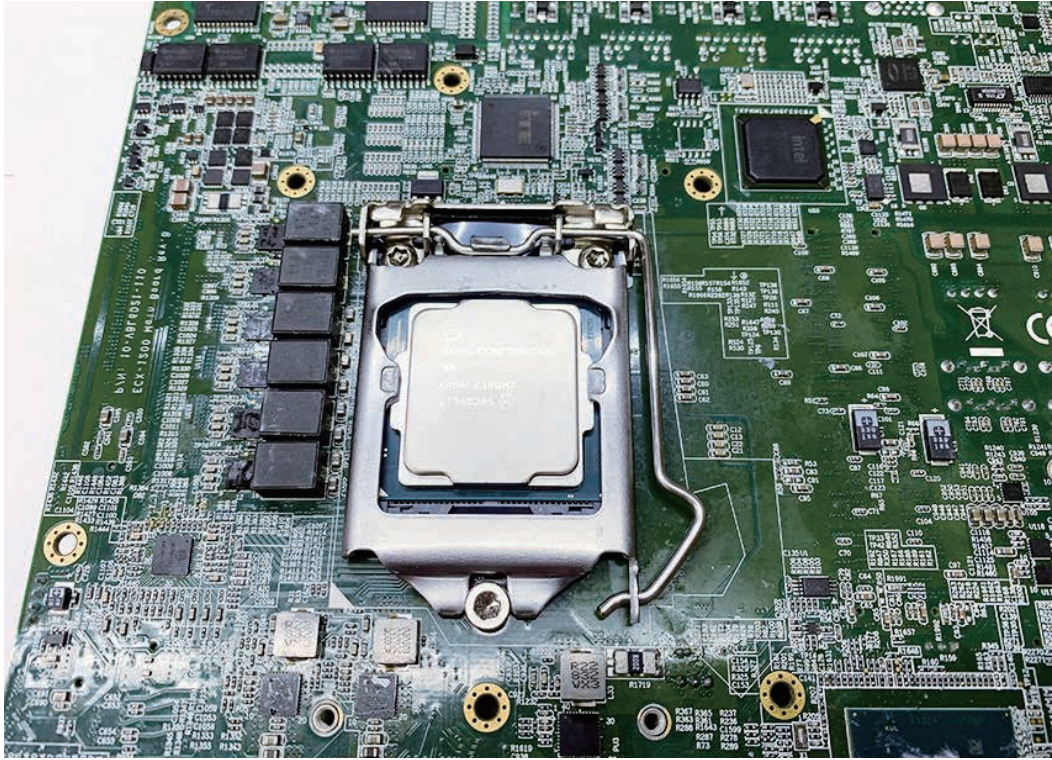

### 3.3 Installing DDR4 SO-DIMM Modules

Step 1 DDR4 SO-DIMM socket.

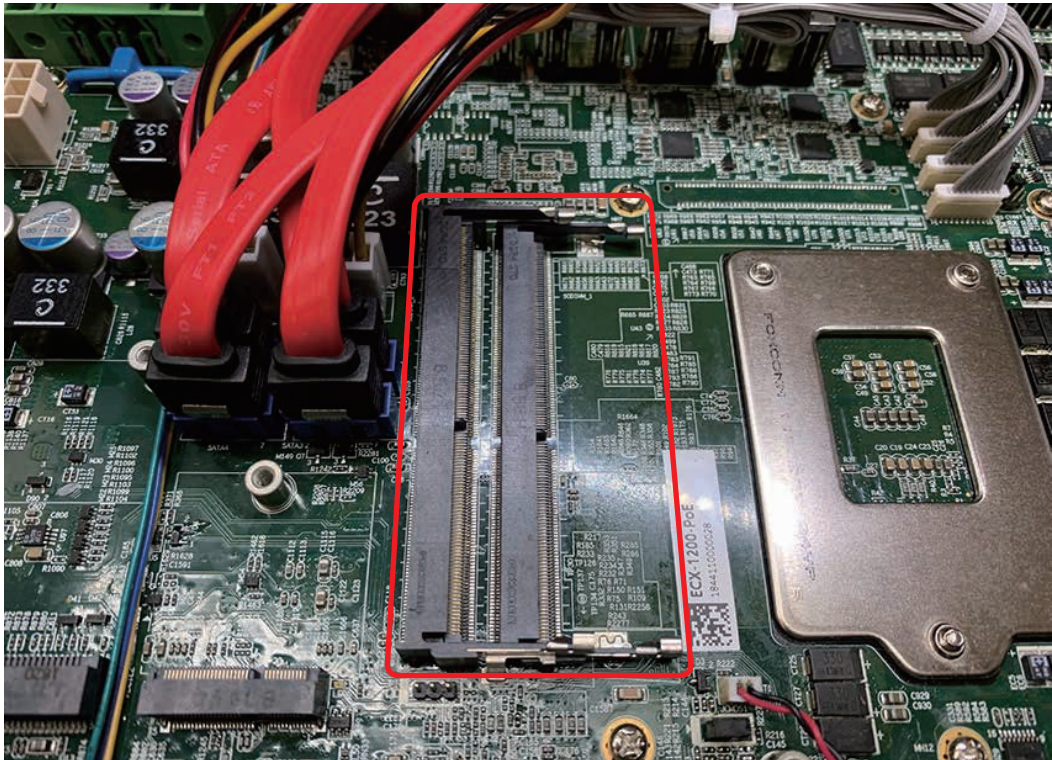

Step 2 Install DDR4 RAM module into SO-DIMM socket and locked.

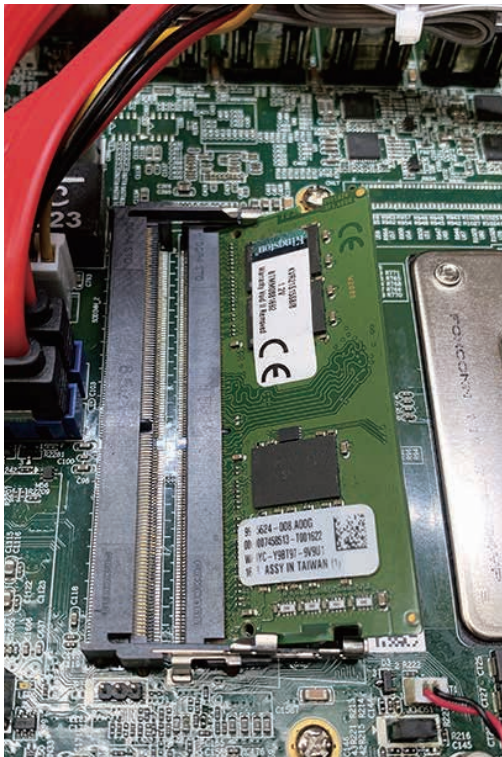

Step 3 Install DDR4 RAM module into SO-DIMM socket and locked.





### 3.4 Installing Mini PCIe Card

Step 1 Mini PCIe socket.

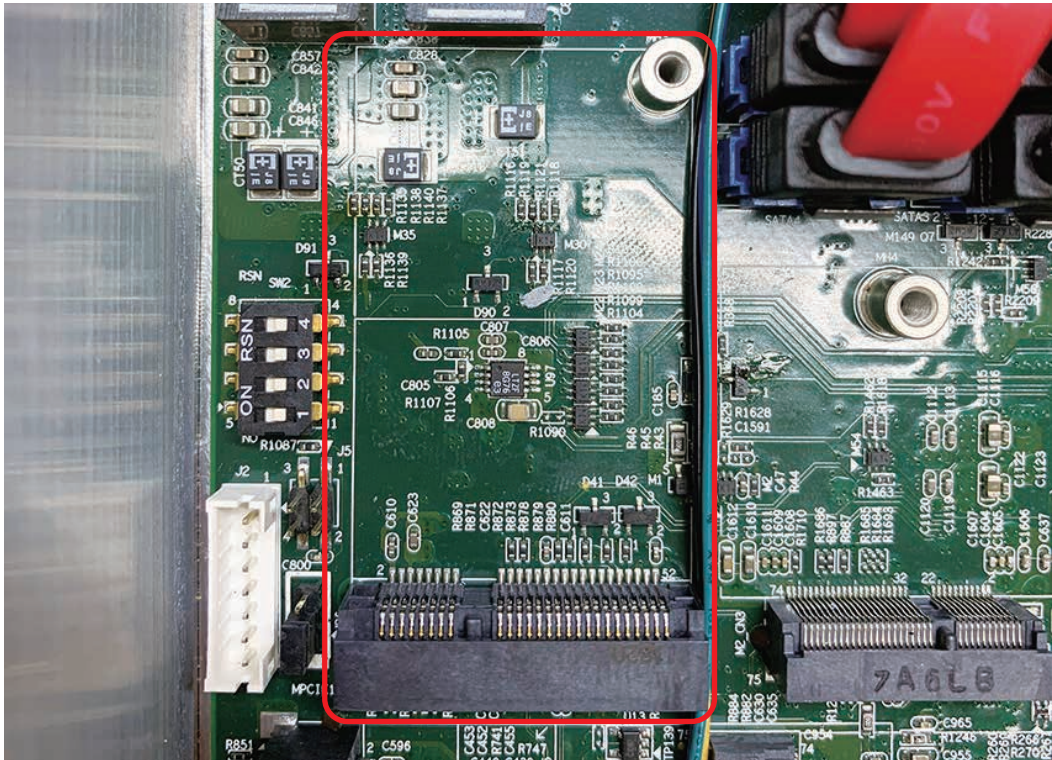

Step 2 Install Mini PCIe card into socket.

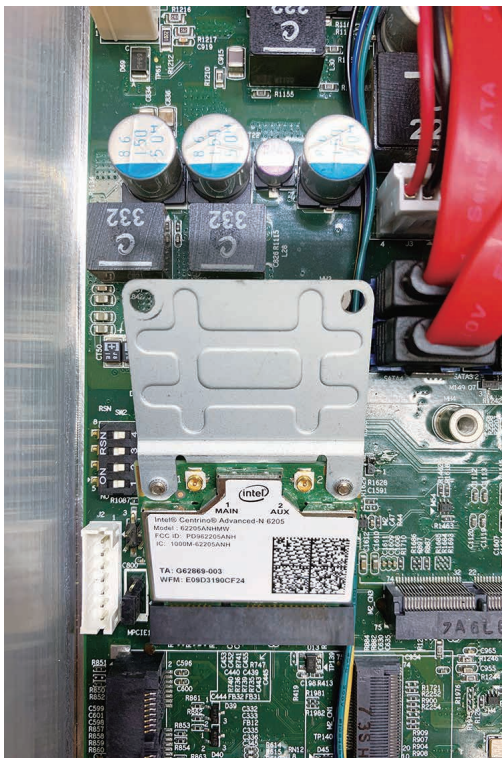

Step 3 Fasten PHILLIPS M2.5 screw.

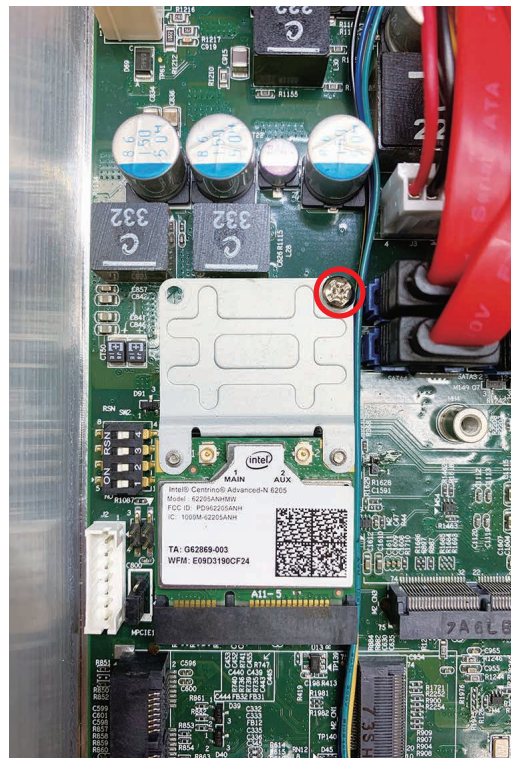

## 3.5 Installing Antenna Cable

**Step 1** Check Antenna cable and washer.



**Step 2** Fasten washer 1 and 2.



**Step 3** Finished.



### 3.6 Installing CFast Card

**Step 1** Remove two PHILLIPS M3 screws on CFast & SIM Card cover at front panel.

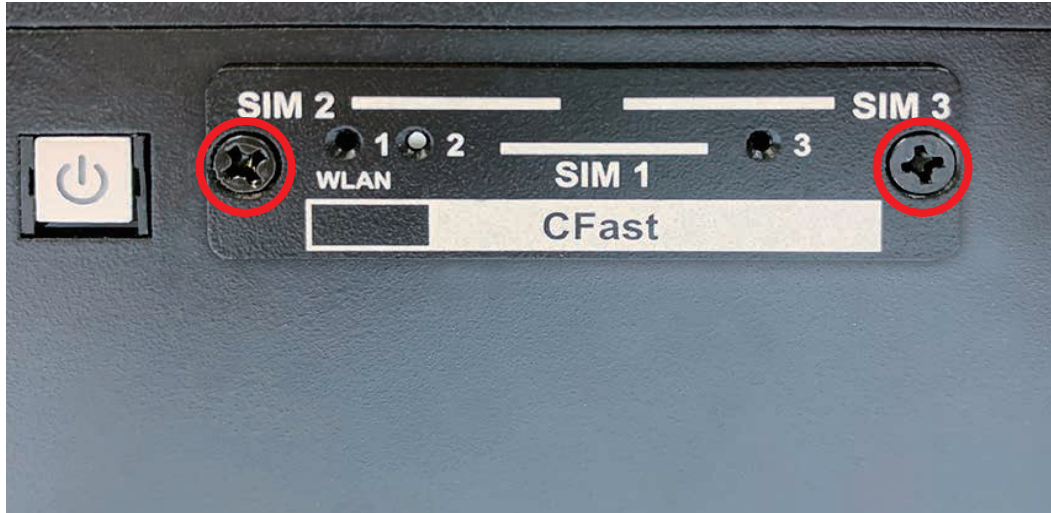

**Step 2** Remove CFast & SIM Card cover.

**Step 3** Before Inserting CFast & SIM Card, make sure the system power is not plugged.

**Step 4** Insert CFast card and push to lock.

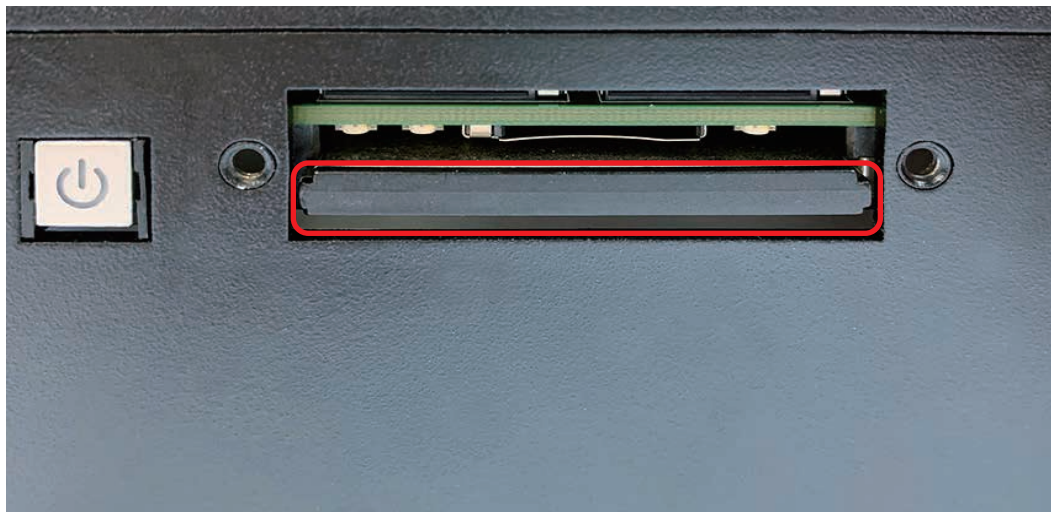

### 3.7 Installing SIM Card

**Step 1** Remove two PHILLIPS M3 screws on CFast & SIM Card cover at front panel.

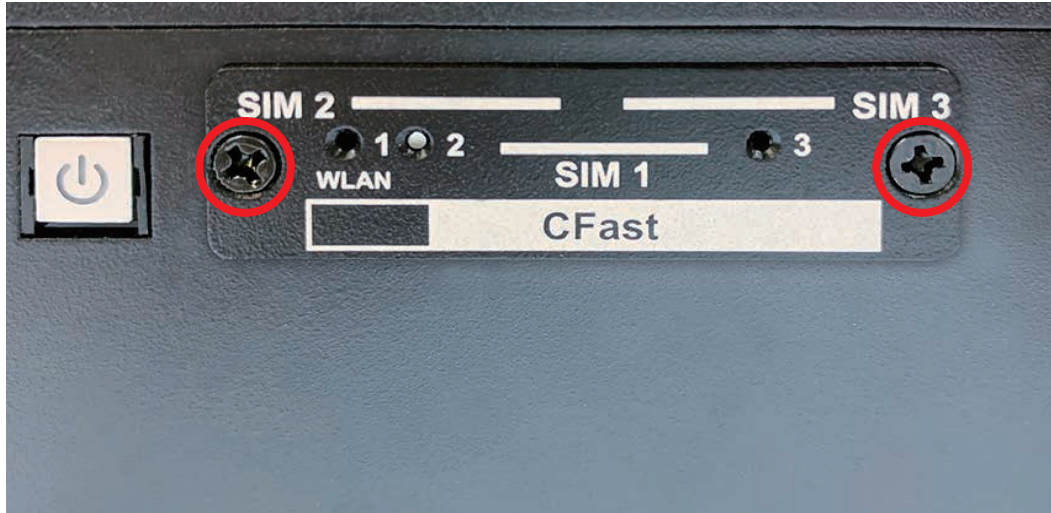

**Step 2** Remove CFast & SIM Card cover.

**Step 3** Before Inserting CFast & SIM Card, make sure the system power is not plugged.

**Step 4** Insert SIM card and push to lock.

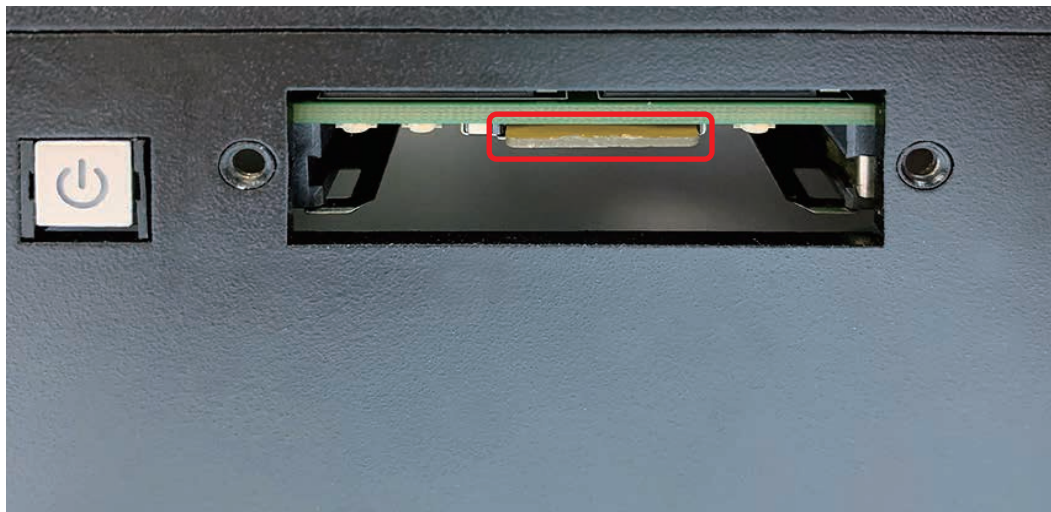

## 3.8 Installing PCI/PCIe Card

### ECX-14/1300:

System designs will support 111.15 mm standard height, 200 mm maximum length (without the I/O bracket & power cable) expansion cards.

### ECX-14/1300-PEG:

System designs will support 111.15 mm standard height, 185 mm maximum length (without the I/O bracket & power cable) expansion cards

(\*Based on the position of power connectors and the card sink/case design, not all expansion card within the maximum dimension can fit in to the system. Please consult the Vecow support team for confirmation.)

**Step 1** Remove PCI bracket and PHILLIPS#6-32 screw.

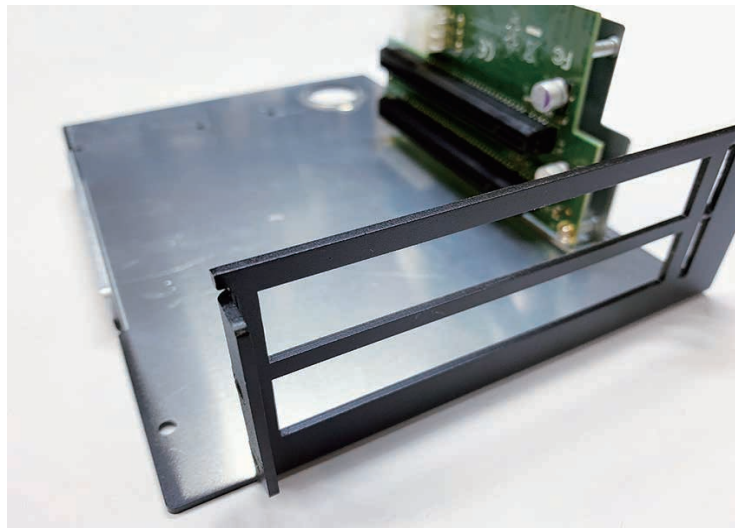

**Step 2** Match the PCI/PCIe card and the tray.

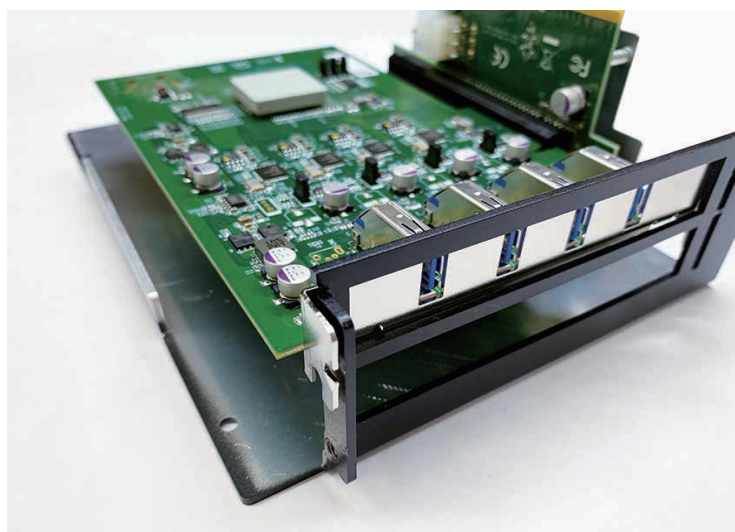

**Step 3** Fasten PHILLIPS#6-32 screw.

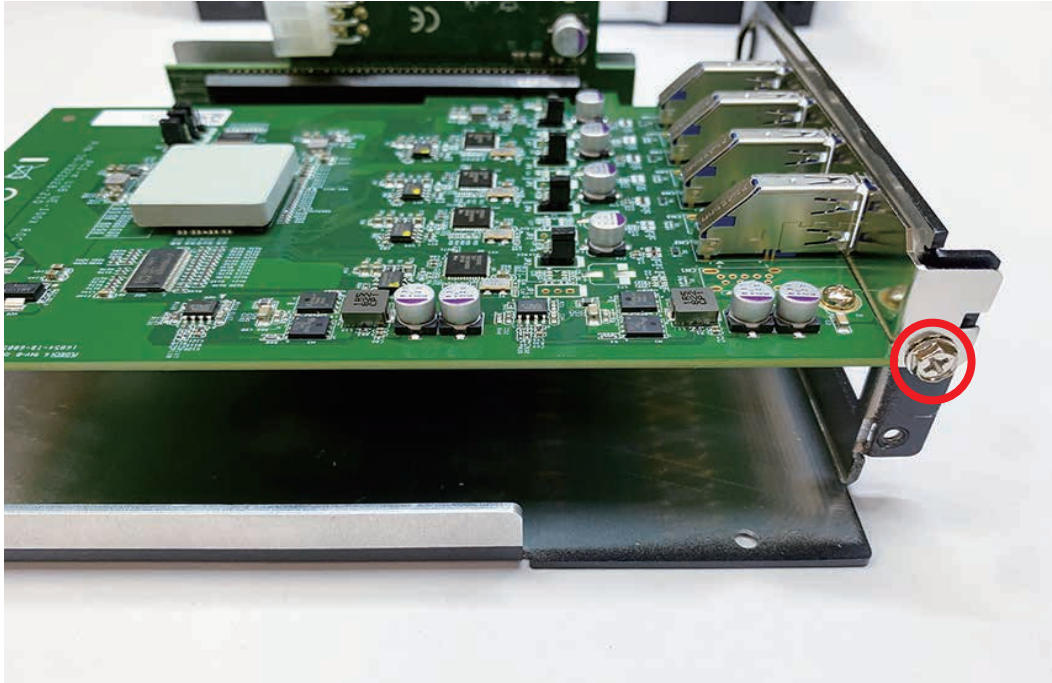

### 3.9 Installing SSD/HDD

**Step 1** Unlock SSD/HDD tray.



**Step 2** Pull the trigger and open SSD/HDD tray.



**Step 3** Install 2.5" SSD/HDD into the tray and then push back to close the tray.



**Step 4** Lock the SSD/HDD tray with key.





## 3.10 Installing M.2

Step 1 M.2 socket.

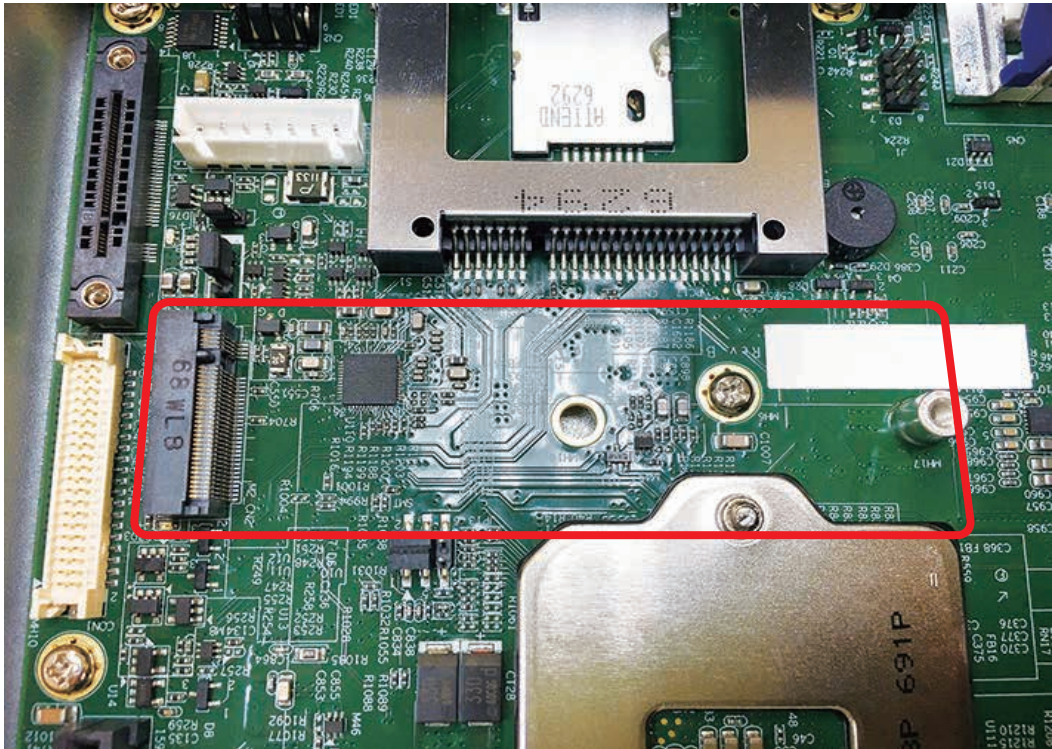

Step 2 Install M.2 into socket and fasten 1pcs PHILLIPS M3 screw.



## 3.11 Mounting Your ECX-1400/1300

### 3.11.1 Wall mount

Fasten six PHILLIPS#10-32 screws.

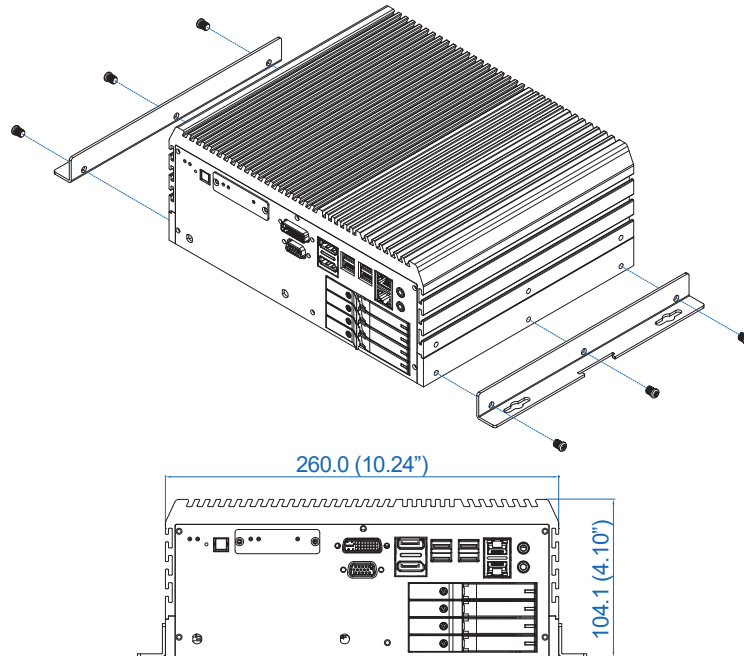

### 3.11.2 VESA mount

Fasten six PHILLIPS#10-32 screws.  
VESA 75 x 75/100 x 100 mm

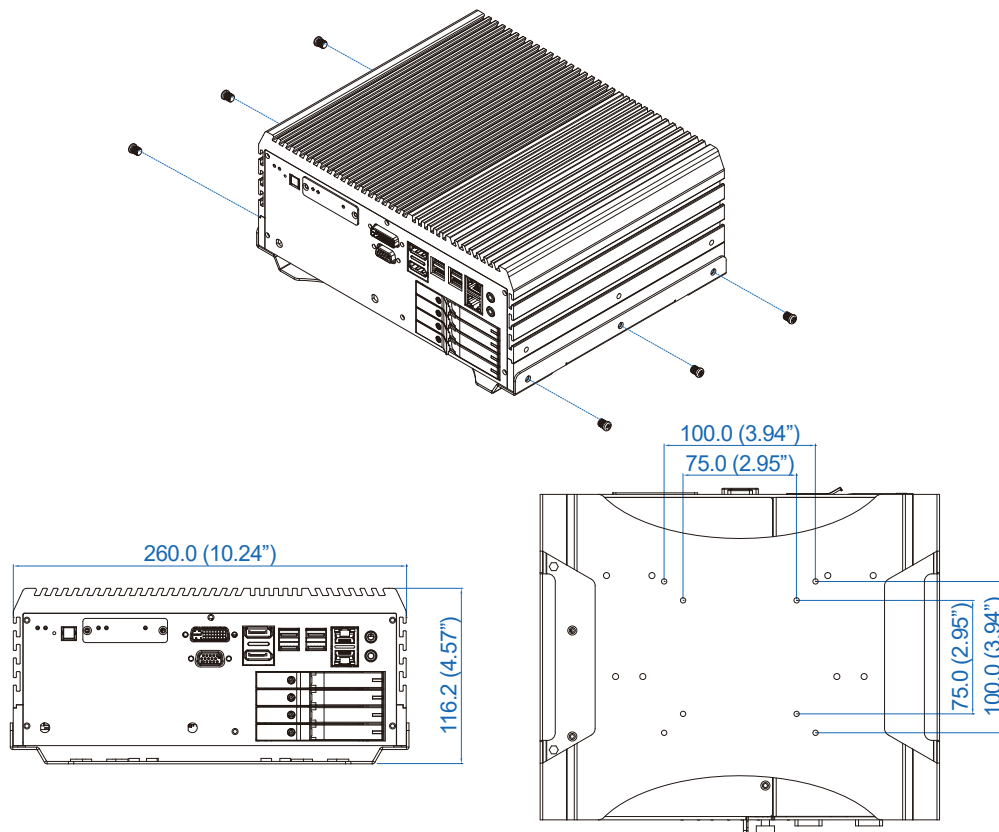

### 3.11.3 Din Rail Kit

Fasten six PHILLIPS#10-32 screws.

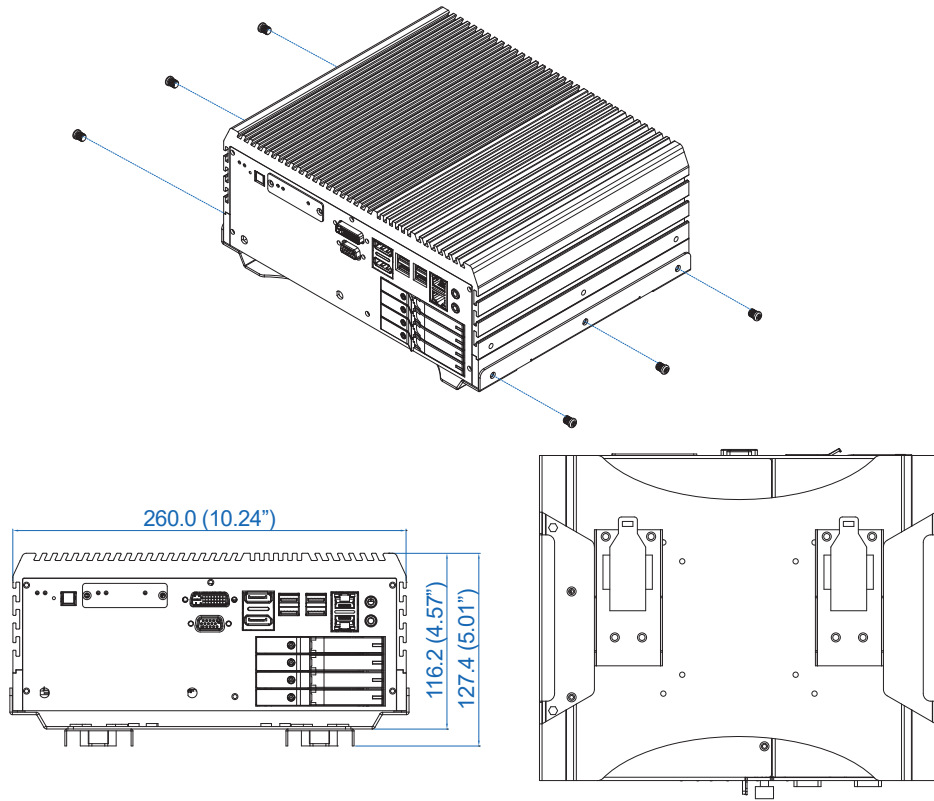

# 4

## BIOS SETUP

### 4.1 Entering BIOS Setup

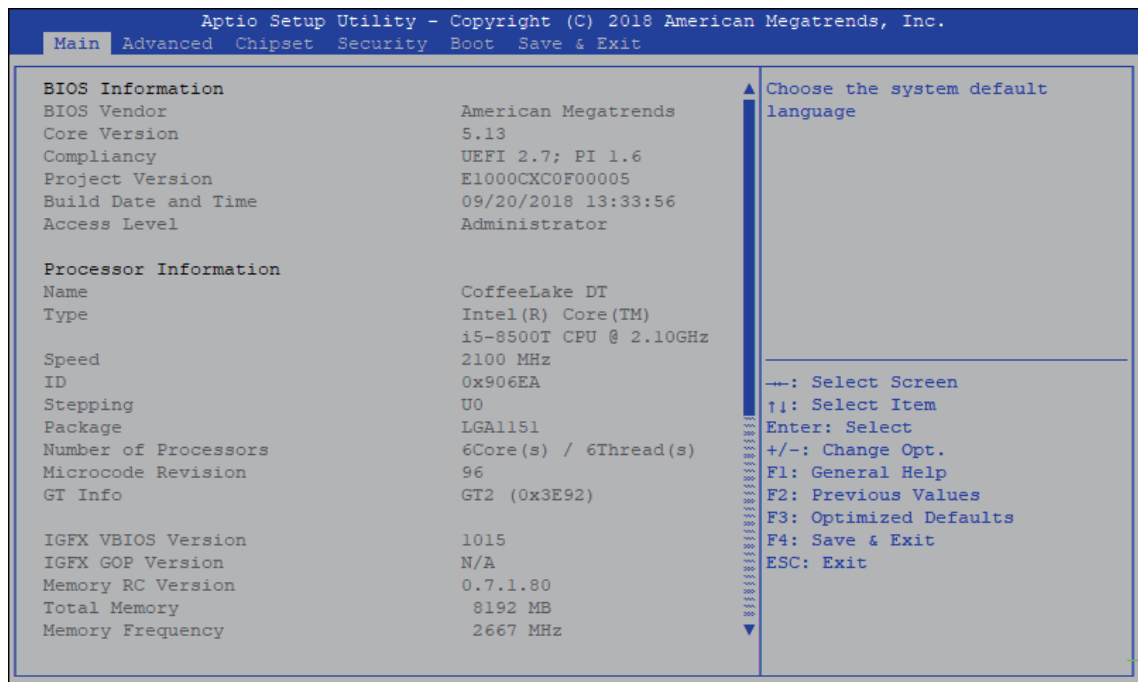

Figure 4-1 : Entering Setup Screen

BIOS provides an interface for users to check and change system configuration. The BIOS setup program is accessed by pressing the <Del> key when POST display output is shown.

## 4.2 Main

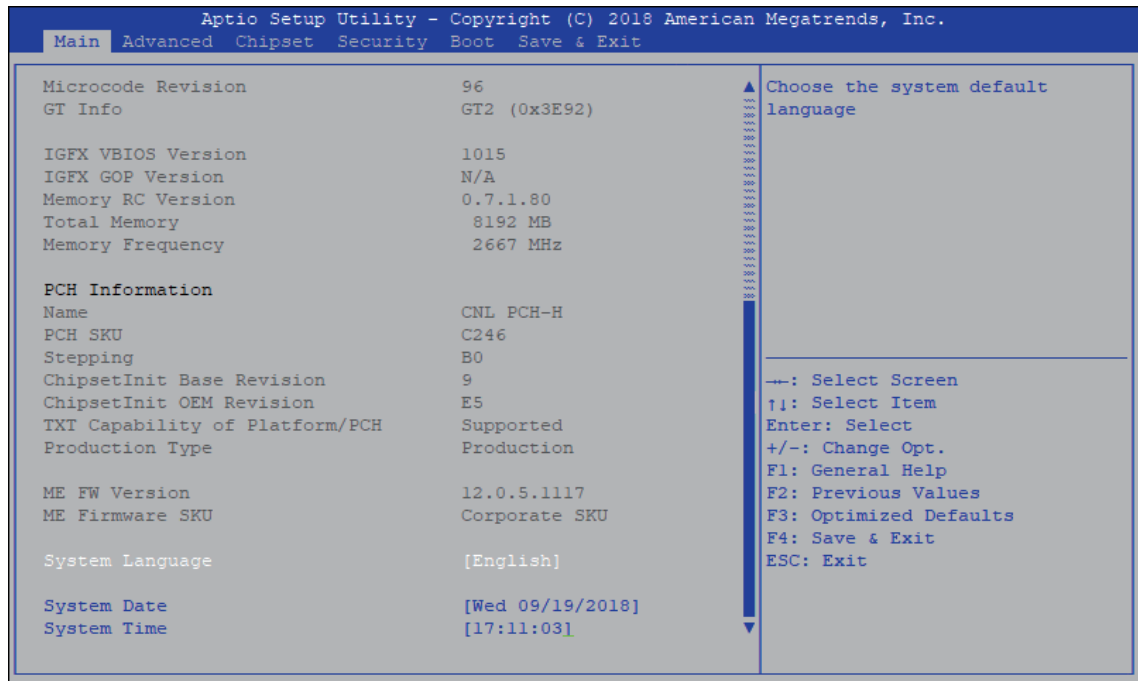

Figure 4-2 : BIOS Main Menu

The main menu displays BIOS version and system information. There are two options on Main menu.

### System Date

Set the date. Use <Tab> to switch between date elements.

### System Time

Set the time. Use <Tab> to switch between time elements.

## 4.3 Advanced

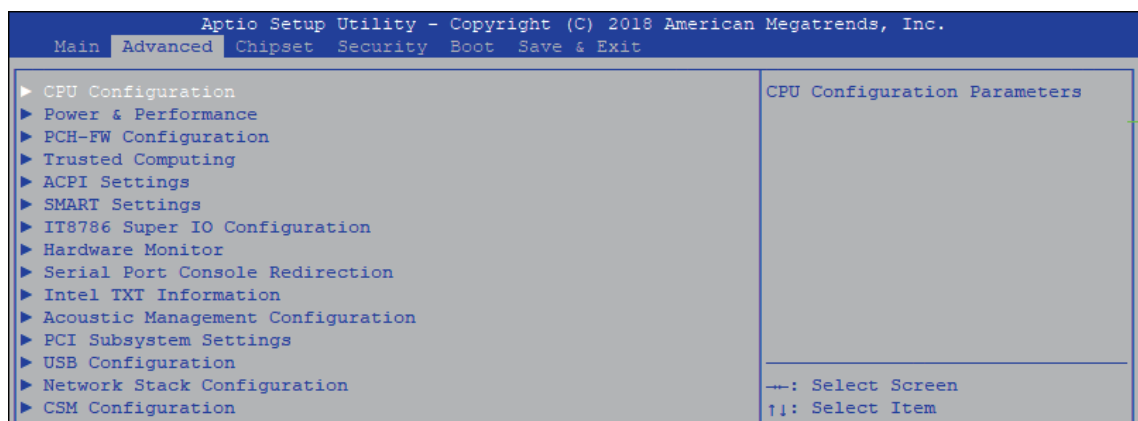

Figure 4-3 : BIOS Advanced Menu

Select advanced tab to enter advanced BIOS setup options, such as CPU configuration, SATA configuration, and USB configuration.

### 4.3.1 CPU Configuration

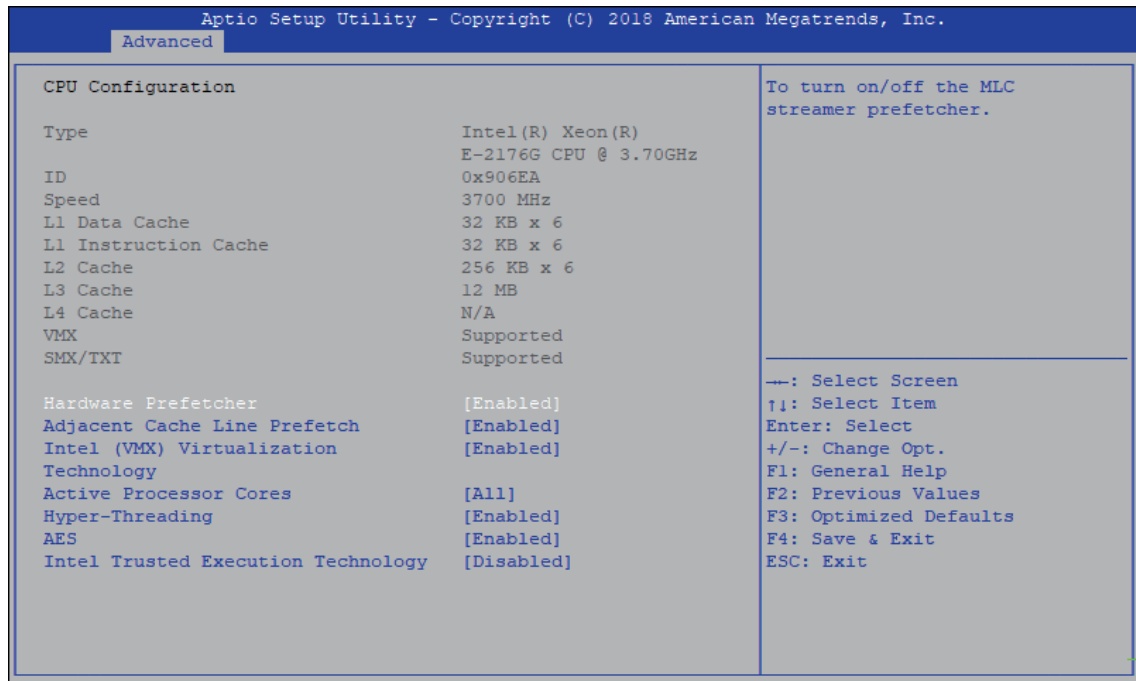

Figure 4-3-1 : CPU Configuration

#### Hardware Prefetcher

To turn on/off the MLC streamer prefetcher.

#### Adjacent Cache Line Prefetch

To turn on/off prefetching of adjacent cache lines.

#### Intel (VMX) Virtualization Technology

When enabled, a VMM can utilize the additional hardware capabilities provided by Vanderpool Technology.

#### Active Processor Cores

Number of cores to enable in each processor package.

#### Hyper-threading

Enabled for Windows XP and Linux (OS optimized for Hyper-Threading Technology) and disabled for other OS (OS not optimized for Hyper-Threading Technology). When disabled only one thread per core is enabled.

#### AES

Enable/disable CPU Advanced Encryption Standard instructions.

#### Intel Trusted Execution Technology

Enables utilization of additional hardware capabilities provided by Intel Trusted Execution Technology.

Changes require a full power cycle to take effect.

## 4.3.2 Power & Performance

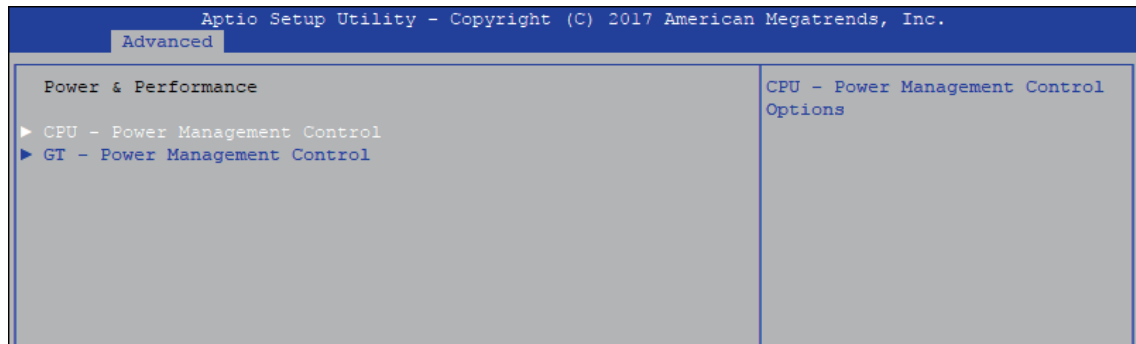

Figure 4-3-2 : Power & Performance

### 4.3.2.1 CPU – Power Management Control

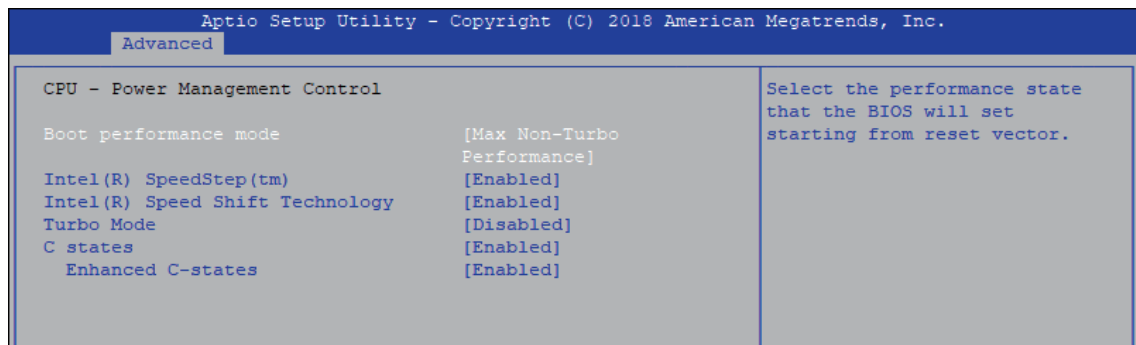

Figure 4-3-2-1 : CPU – Power Management Control

#### Boot performance mode

Select the performance state that the BIOS will set before OS handoff.

#### Intel(R) SpeedStep(tm)

Allows more than two frequency ranges to be supported.

#### Intel(R) Speed shift Technology

Enable/Disable Intel® Speed Shift Technology support. Enabling will expose the CPPCV2 interface to allow for hardware controlled P-states.

#### Turbo Mode

Turbo Mode.

#### C states

Enable or disable CPU C states.

#### Enhanced C-states

Enable/disable C1E. When enabled, CPU will switch to minimum speed when all cores enter C-State.

### 4.3.2.2 GT – Power Management Control

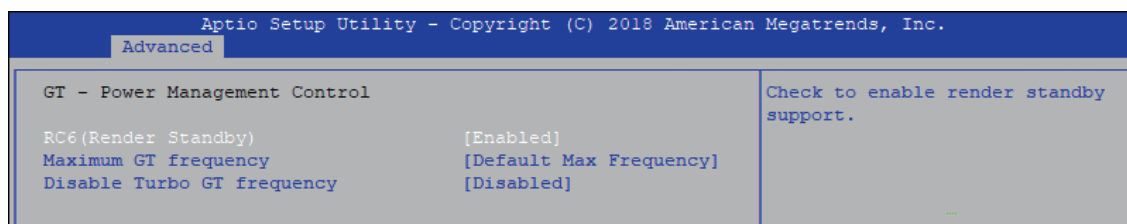

Figure 4-3-2-2 : GT – Power Management Control

#### RC6 (Render Standby)

Check to enable render standby support.

#### Maximum GT frequency

Maximum GT frequency limited by the user. Choose between 350MHz (RPN) and 1150MHz (RP0). Value beyond the range will be clopped to min/max supported by SKU

#### Disable Turbo GT frequency

Check to enable render standby support.

### 4.3.3 PCH-FW Configuration



Figure 4-3-3 : PCH-FW Settings

#### ME State

Set ME to Soft temporarily disabled.

#### AMT BIOS Features

When disabled AMT BIOS Features are no longer supported and user is no longer able to access MEBx Setup.

#### AMT Configuration

Configure Intel® Active Management Technology Parameters.

#### ME Unconfig on RTC Clear State

Disabling this option will cause ME not to unconfigure on RTC clear.



### 4.3.4 Trusted Computing

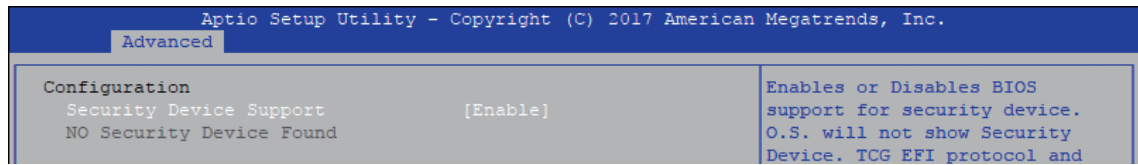

Figure 4-3-4 : Trusted Computing

Control the TPM device status and display related information if TPM chip is present.

### 4.3.5 ACPI Settings

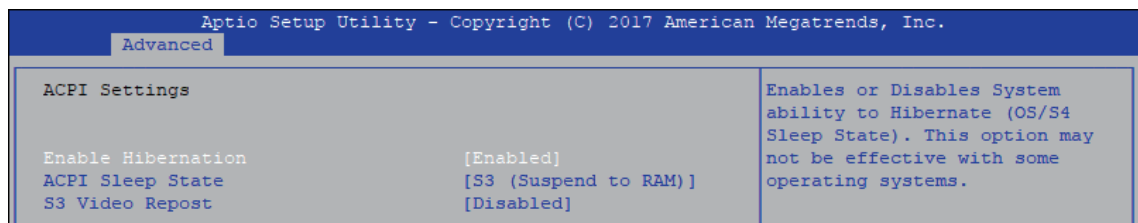

Figure 4-3-5 : ACPI Settings

#### Enable Hibernation

Enables or disables system's ability to hibernate (OS/S4 sleep state). This option may not be effective with some OS.

#### ACPI Sleep State

Selects the highest ACPI sleep state the system will enter when the SUSPEND button is pressed.

#### S3 Video Repost

Enables or disables S3 video repost.

### 4.3.6 SMART Settings

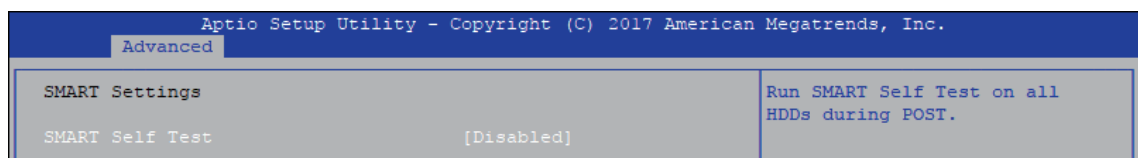

Figure 4-3-6 : SMART Settings

#### SMART Self Test

Run SMART self test on all HDDs during POST.

### 4.3.7 IT8786 Super IO Configuration

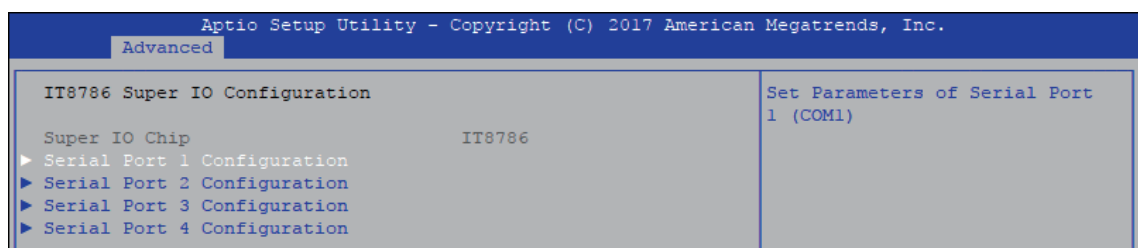

Figure 4-3-7 : IT8786 Super IO Settings

### 4.3.7.1 Serial Port X Configuration

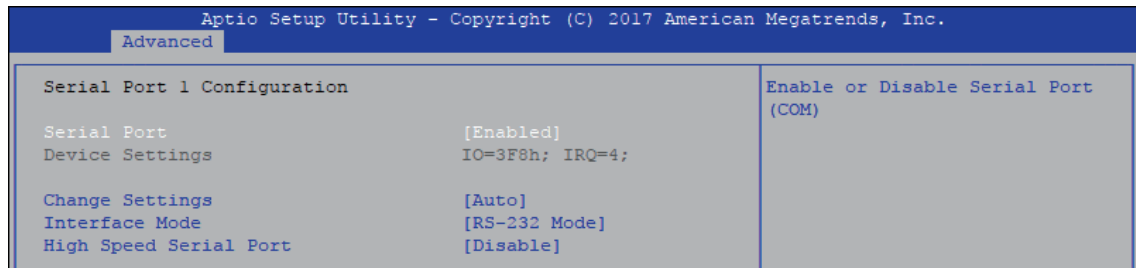

Figure 4-3-7-1 : Serial Port X Configuration

### Serial Port 1 to port 4 Configuration

Options for Serial Port 1 to Serial Port 4.

Entering the corresponding Port option then end user can change the settings such as I/O resource and UART mode (High Speed Serial Port is Port 1 only).

### 4.3.8 Hardware Monitor

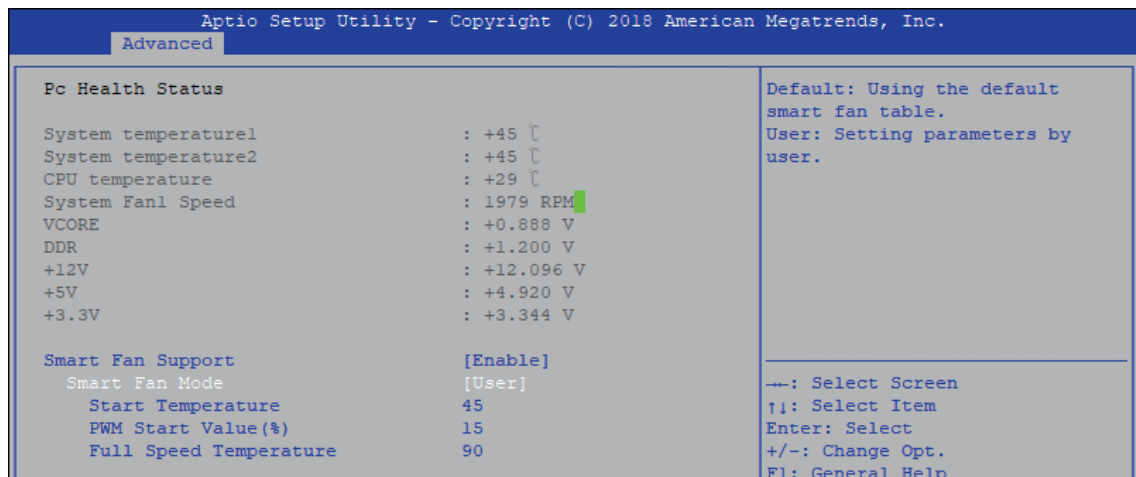

Figure 4-3-8 : Hardware Monitor Settings

The IT8786 SIO features an enhanced hardware monitor providing thermal, fan speed, and system voltages' status monitoring.

#### Smart Fan Support

Smart Fan Support. Work with Full Speed if "Smart Fan Support" is Disabled.

#### Smart Fan Mode

Default : Using the default smart fan table.

User : Setting parameters by user.

#### Start Temperature

Temperature Limit value of Fan Start (Degree C).

(Range : 10~80)

#### PWM Start Value (%)

Default PWM Value of Fan.

(Range : 15%~100%)

#### Full Speed Temperature

Temperature Limit value of Fan Full Speed (Degree C).

(Range : 50~90)

### 4.3.9 Serial Port Console Redirection

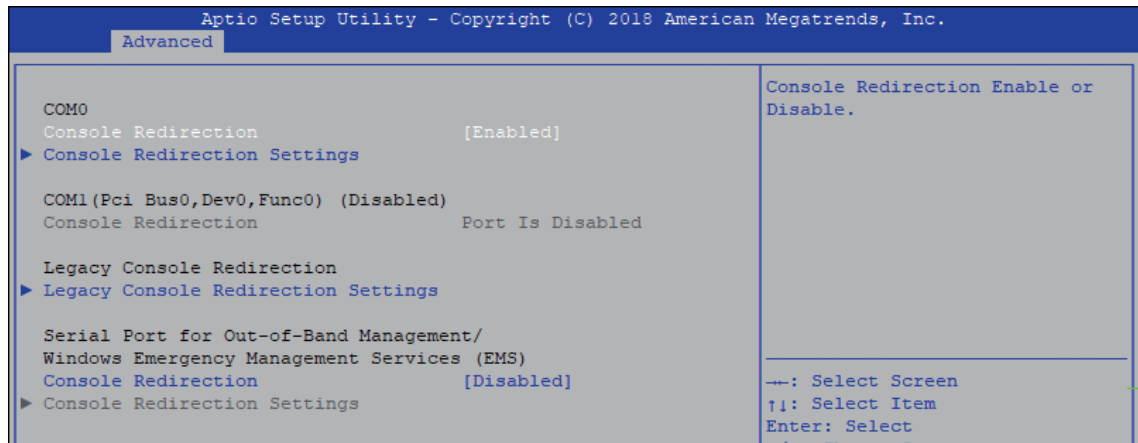

Figure 4-3-9 : Serial Port Console Redirection Settings

#### Console Redirection

Console redirection enable or disable.

#### Console Redirection Settings

These settings specify how the host computer and the remote computer (which the user is using) will exchange data. Both computers should have the same or compatible settings.

#### Legacy Console Redirection

Legacy Console Redirection Settings.

#### Serial Port for Out-of-Band Management/Windows Emergency Management Services (EMS)

Console redirection enable or disable.

### 4.3.10 Intel TXT Information



Figure 4-3-10 : Intel TXT Information

Display Intel TXT information.

### 4.3.11 Acoustic Management Configuration

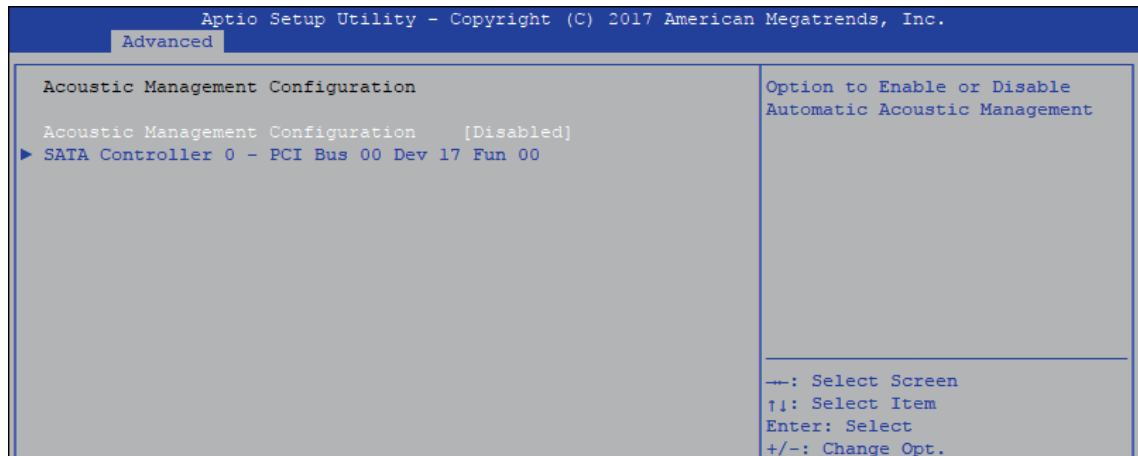

Figure 4-3-11 : Acoustic Management Settings

#### Acoustic Management Configuration

Option to enable or disable automatic acoustic management.

### 4.3.12 PCI Subsystem Setting

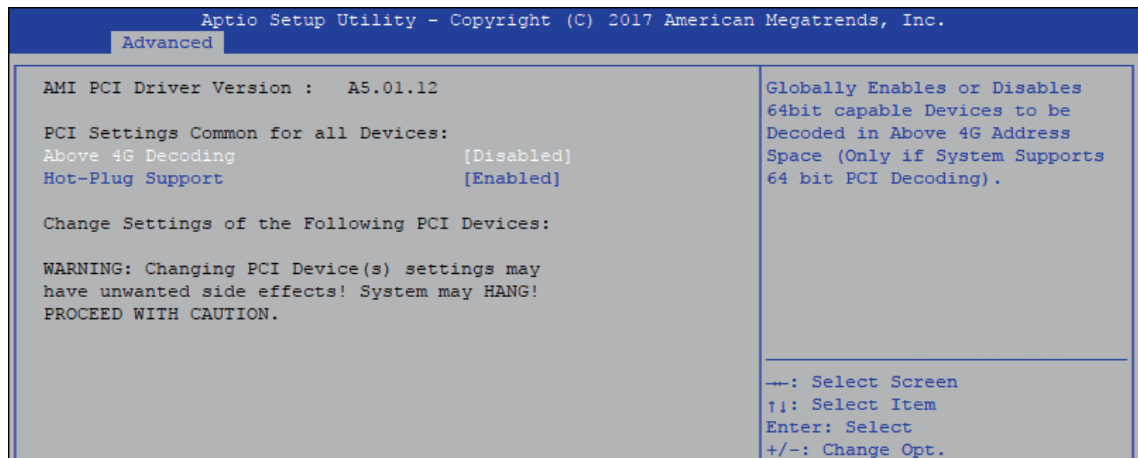

Figure 4-3-12 : PCI Subsystem Settings

#### Above 4G Decoding

Globally Enables or Disables 64bit capable Devices to be Decoded in Above 4G Address Space (Only if System Supports bot PCI Decoding)

#### Hot-Plug Support

Globally Enables or Disables Hot-Plug support for the entire System. If system has Hot-Plug Capable Slots and this option set to Enabled, it provides a Setup screen for selecting PCI resource padding for Hot-Plug.

### 4.3.13 Network Stack Configuration

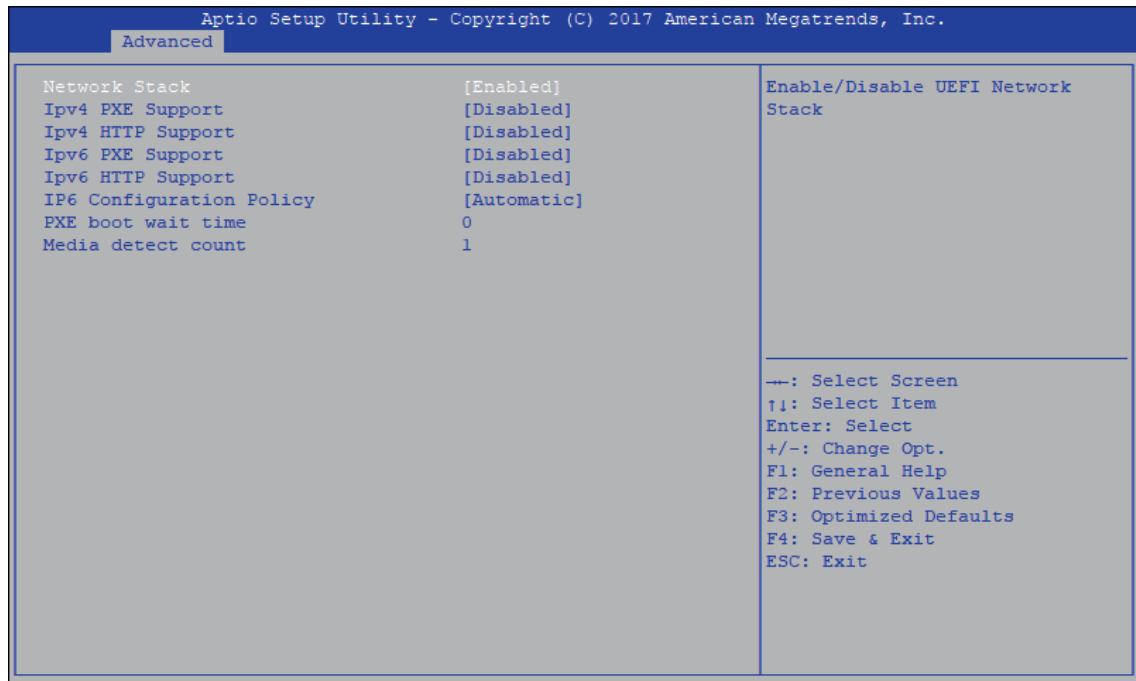

Figure 4-3-13 : Network Stack Settings

#### **Network Stack**

Enable/Disable UEFI Network Stack

#### **Ipv4 PXE Support**

Enable/Disable IPv4 PXE boot support.

#### **Ipv4 HTTP Support**

Enable/Disable IPv4 HTTP boot support.

#### **Ipv6 PXE Support**

Enable/Disable IPv6 PXE boot support.

#### **Ipv6 HTTP Support**

Enable/Disable IPv6 HTTP boot support.

#### **IP6 Configuration Policy**

Set IP6 Configuration Policy.

#### **PXE boot wait time**

Wait time to press ESC key to abort the PXE boot.

#### **Media detect count**

Number of times presence of media will be checked.

### 4.3.14 CSM Configuration

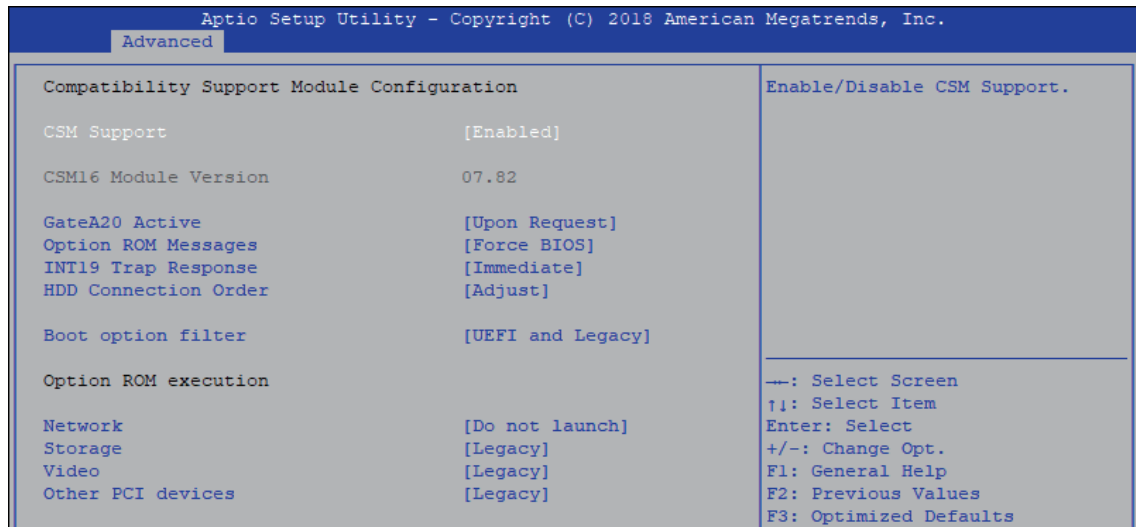

Figure 4-3-14 : CSM Settings

#### CSM Support

Enable/disable CSM support

#### GateA20 Active

UPON REQUEST - GA20 can be disabled using BIOS services.

ALWAYS - do not allow GA20 to be disabled; this option is useful when any RT code is executed above 1MB.

#### Option ROM Messages

Set display mode for Option ROM.

#### INT19 Trap Response

BIOS reaction on INT19 trapping by Option ROM :

IMMEDIATE - execute the trap right away;

POSTPONED - execute the trap during legacy boot.

#### HDD Connection Order

Some OS require HDD handles to be adjusted, i.e. OS is installed on drive 80h.

#### Boot option filter

This option controls Legacy/UEFI ROM's priority.

#### Network

Controls the execution of UEFI and Legacy PXE OpROM.

#### Storage

Controls the execution of UEFI and Legacy Storage OpROM.

#### Video

Allows more than two frequency ranges to be supported.

#### Other PCI devices

Determines OpROM execution policy for devices other than network, storage, or video.

### 4.3.15 NVMe Configuration

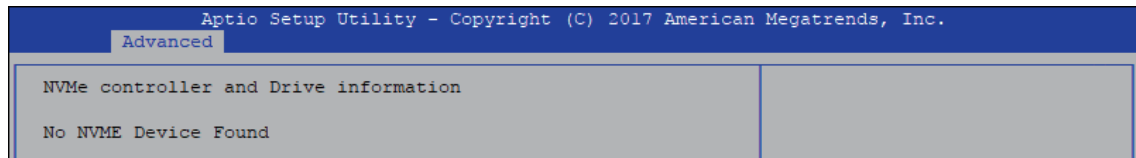

Figure 4-3-15 : NVMe Settings

Display NVMe controller and Drive information.

### 4.3.16 USB Configuration

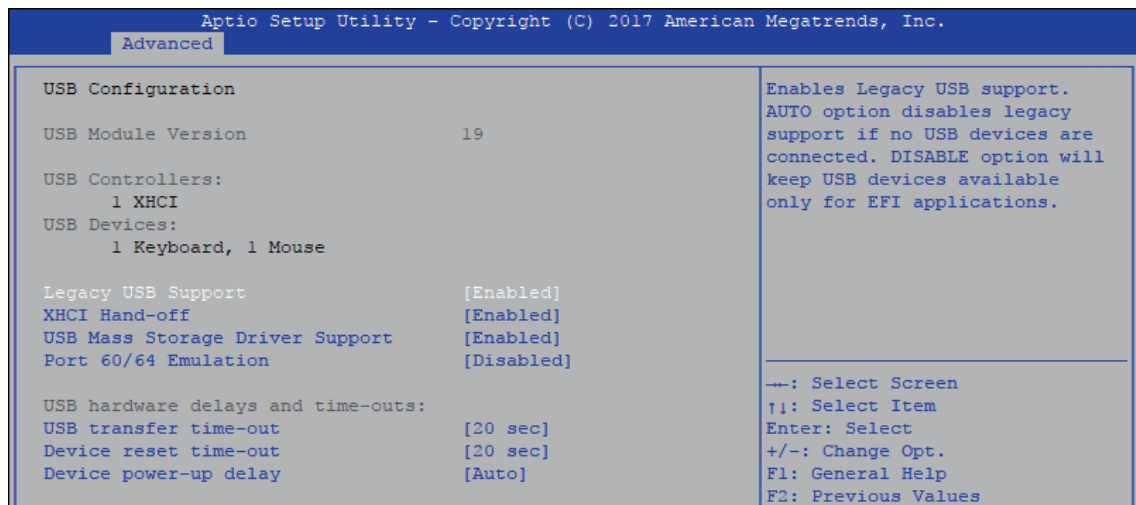

Figure 4-3-16 : USB Settings

#### Legacy USB Support

Enables Legacy USB support.

AUTO option disables Legacy support if no USB devices are connected.

DISABLE option will keep USB devices available only for EFI applications.

#### XHCI Hand-off

This is a workaround for OS-es without XHCI hand-off support. The XHCI ownership change should be claimed by XHCI driver.

#### USB Mass Storage Driver Support

Enable/disable USB mass storage driver support.

#### Port 60/64 Emulation

Enables I/O port 60h/64h emulation support. This should be enabled for the complete USB keyboard legacy support for non-USB aware OSes.

#### USB transfer time-out

The time-out value for control, bulk, and interrupt transfers.

#### Device reset time-out

USB mass storage device start unit command time-out.

#### Device power-up delay

Maximum time the device will take before it properly reports itself to the Host Controller. 'Auto' uses default value, for a root port it is 100 ms, for a hub port the delay is taken from the hub descriptor.

## 4.4 Chipset

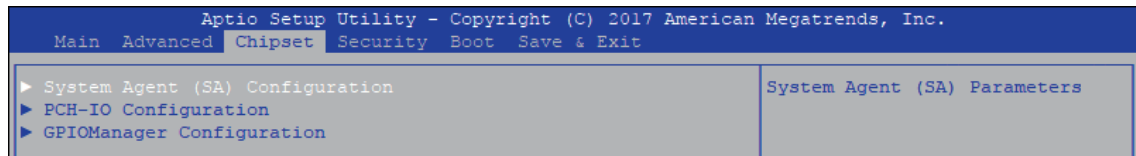

Figure 4-4 : BIOS Chipset Menu

### System Agent (SA) Configuration

System Agent (SA) parameters.

### PCH-IO Configuration

PCH parameters.

### GPIOManager Configuration

GPIOManager Configuration.

#### 4.4.1 System Agent (SA) Configuration

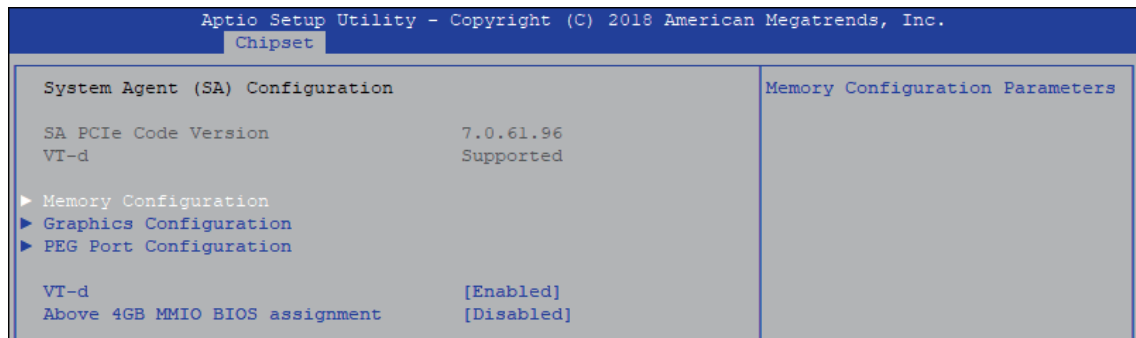

Figure 4-4-1 : System Agent Settings

### VT-d

VT-d capability.

### Above 4GB MMIO BIOS assignment

Enable/disable above 4GB MemoryMappedIO BIOS assignment. This is disabled automatically when aperture size is set to 2048MB.

#### 4.4.1.1 Memory Configuration

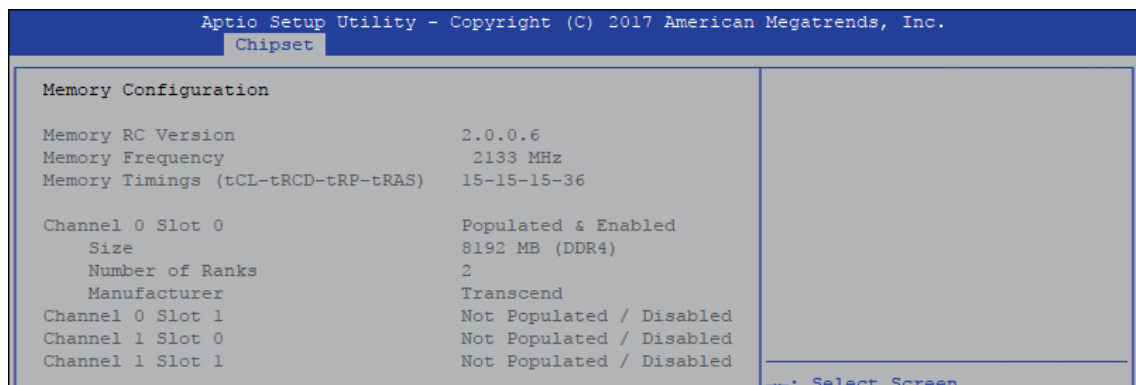

Figure 4-4-1-1 : Memory Information

Displays memory information.



## 4.4.1.2 Graphics Configuration

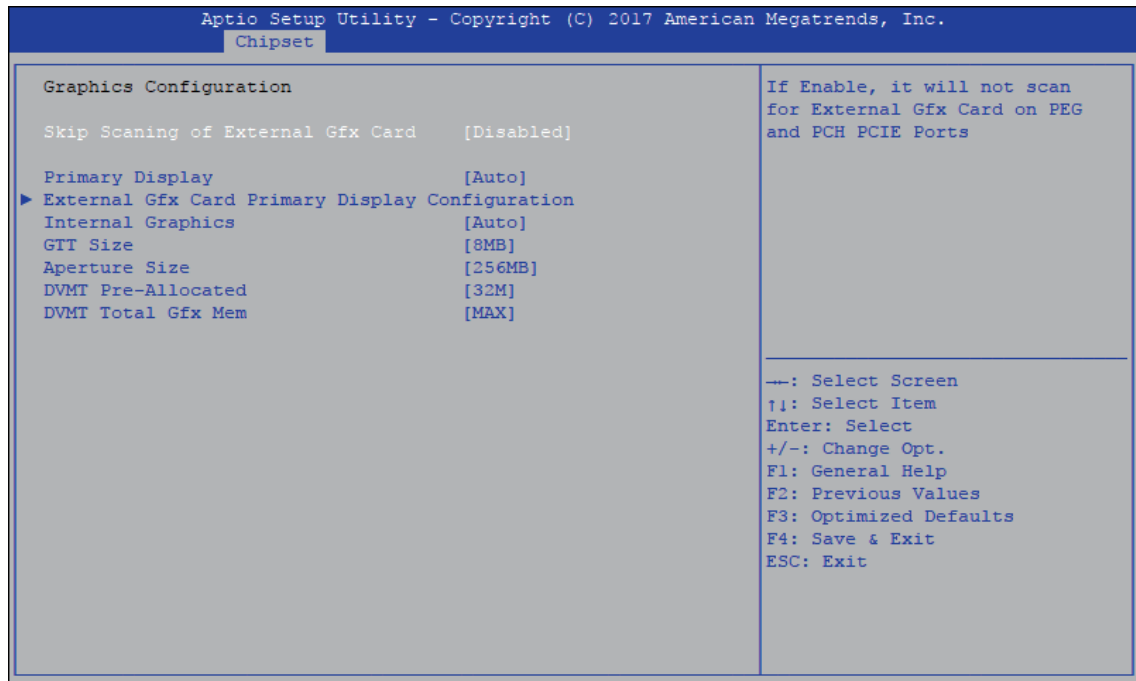

Figure 4-4-1-2 : Graphics Settings

### Skip Scanning of External Gfx Card

If Enable, it will not scan for External Gfx Card on PEG and PCH PCIE Ports.

### Primary Display

Select which of IGFX/PEG/PCI Graphics device should be Primary Display Or select SG for Switchable Gfx.

### Internal graphics

Keep IGFX enabled based on the setup options.

### GTT Size

Select the GTT Size.

### Aperture Size

Select the Aperture Size.

Note : Above 4GB MMIO BIOS assignment is automatically enabled when selecting 2048MB aperture. To use this feature, please disable CSM Support.

### DVMT Pre-Allocated

Select DVMT 5.0 Pre-Allocated (Fixed) Graphics Memory size used by the Internal Graphics Device.

### DVMT Total Gfx Mem

Select DVMT5.0 Total Graphic Memory size used by the Internal Graphics Device.

### 4.4.1.3 PEG Port Configuration

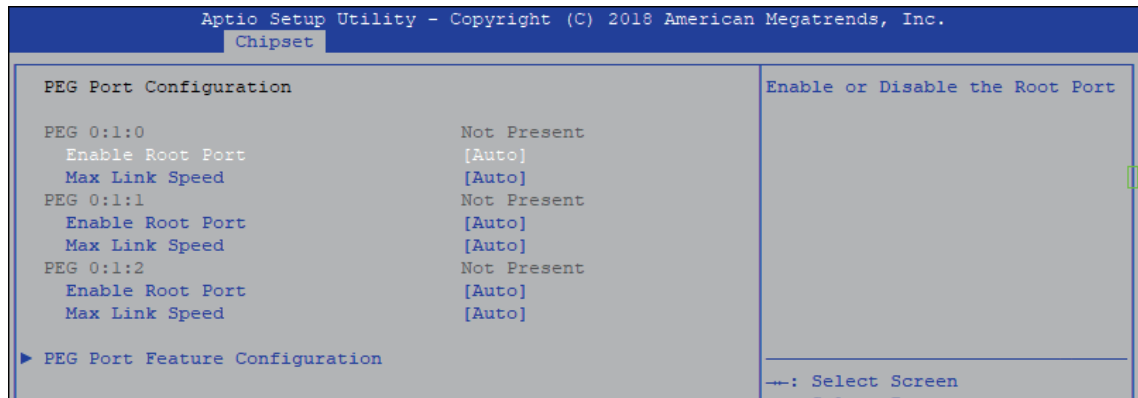

Figure 4-4-1-3 : PEG Port Configuration

PEG port options for PCIe device.

### 4.4.2 PCH-IO Configuration

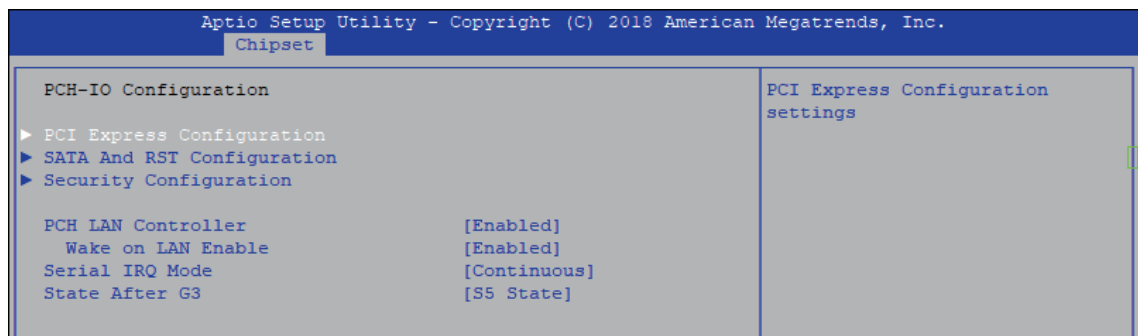

Figure 4-4-2 : PCH-IO Settings

#### PCH LAN Controller

Enable or disable onboard NIC.

#### Wake on LAN

Enable or disable integrated LAN to wake the system. (The wake On LAN cannot be disabled if ME is on at Sx state.)

#### Serial IRQ Mode

Configure serial IRQ mode.

#### State After G3

Specify what state to go to when power is re-applied after a power failure (G3 state).

S0 State : Always turn-on the system when power source plugged-in.

S5 State : Always turn-off the system when power source plugged-in.

## 4.4.2.1 PCI Express Configuration of PCH-IO

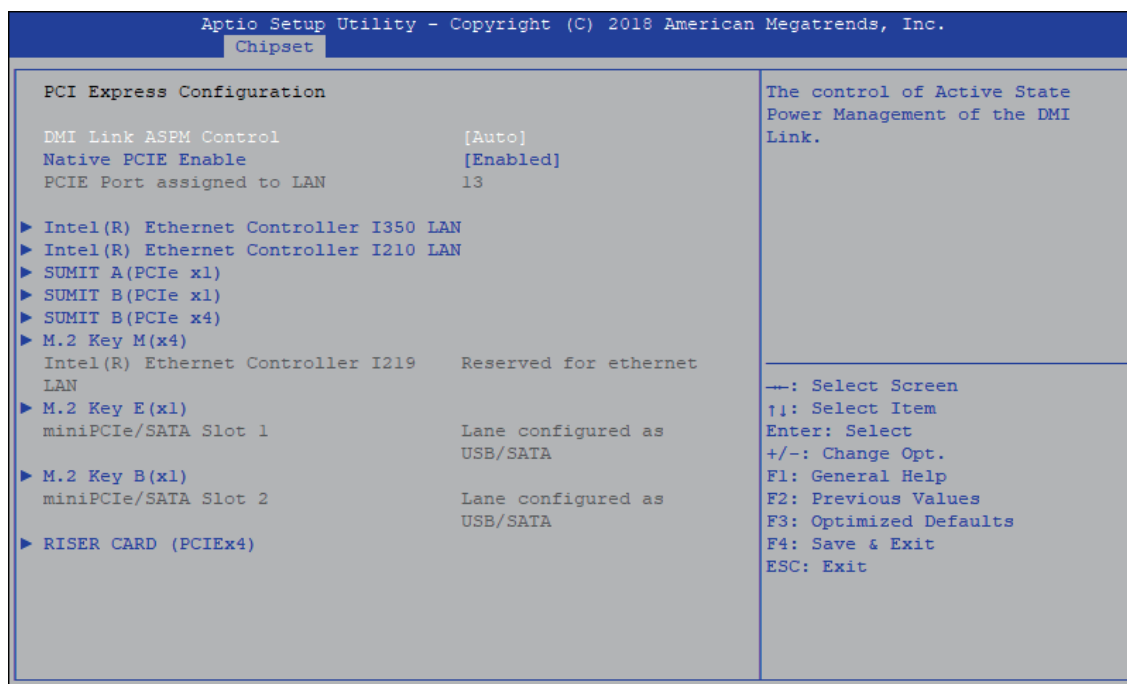

Figure 4-4-2-1 : PCH-IO Settings

### DMI Link ASPM Control

Enable/Disable the control of Active State Power Management on SA side of the DMI Link.

### Native PCIE Enable

PCI Express Native Support Enable/Disable.

### PCI Express device settings

Bios options for PCI Express device setting.

## 4.4.2.2 SATA and RST Configuration

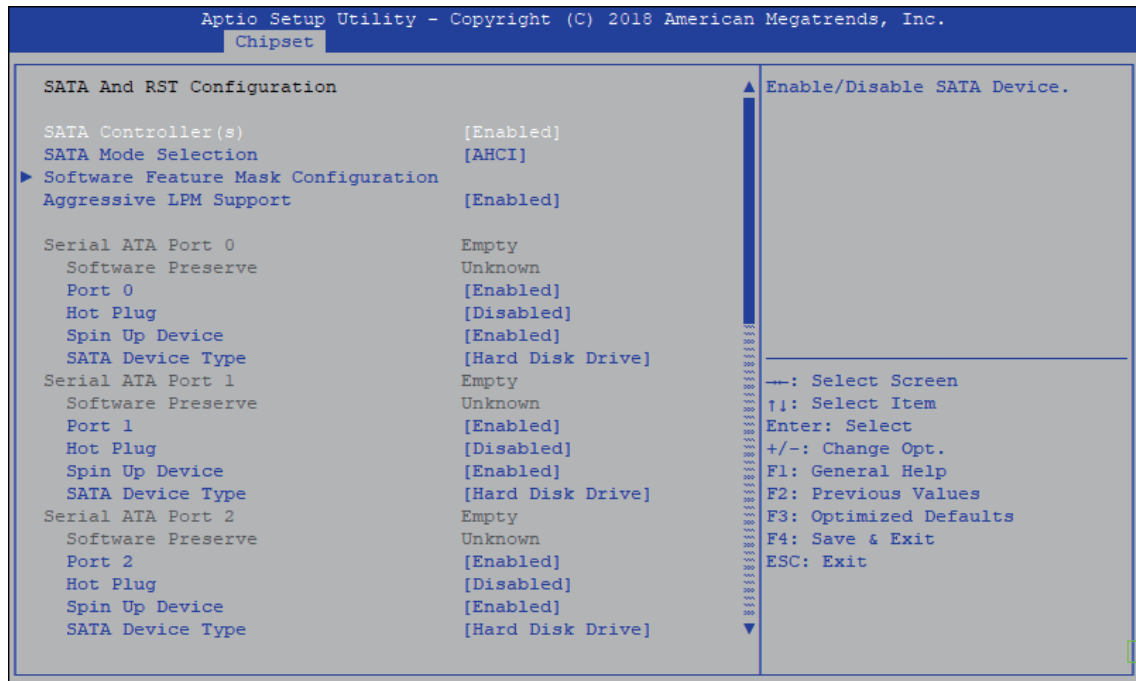

Figure 4-4-2-2 : SATA and RST Settings

### SATA Controller(s)

Enable or disable SATA Device.

### SATA Mode Selection

Determines how SATA controller(s) operate.

### Software Feature Mask Configuration

RAID OROM/RST driver will refer to the SWFM configuration to enable or disable the storage features.

### Aggressive LPM Support

Enable PCH to aggressively enter link power state.

### Options for each SATA port

Port n

Enable or disable SATA Port.

### Hot Plug

Designated this port as Hot Pluggable.

### Spin Up Device

On an edge detect from 0 to 1, the PCH starts a COMRESET initialization sequence to the device.

### SATA Device Type

Identifies that the SATA port is connected to solid state drive or hard disk drive.

### 4.4.2.3 Security Configuration

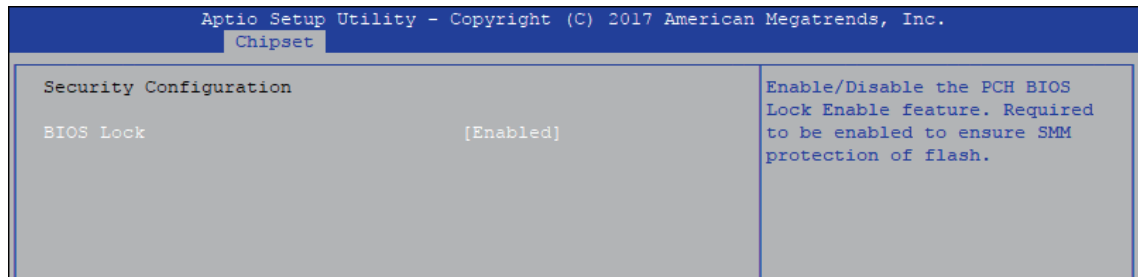

Figure 4-4-2-3 : Security Settings

#### BIOS Lock

Enable/disable the PCH BIOS Lock Enable (BLE bit) feature.

## 4.5 Security

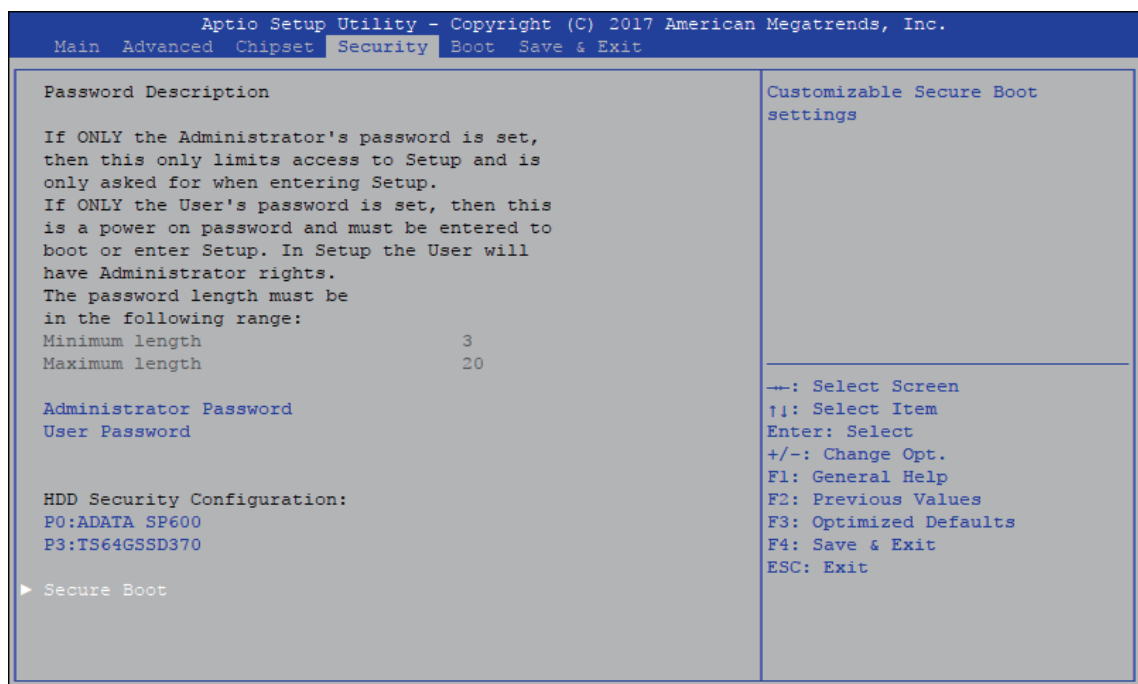

Figure 4-5 : BIOS Security Menu

#### Administrator Password

Set administrator password.

#### User Password

Set user password.

#### Secure Boot

Customizable Secure Boot Settings.

## 4.5.1 HDD Security Configuration

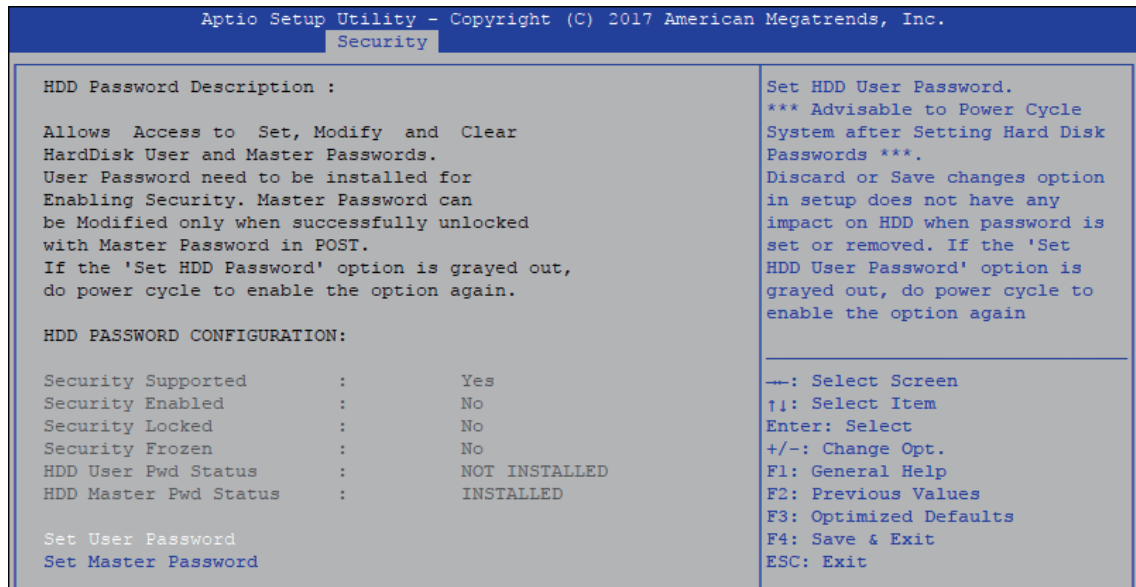

Figure 4-5-1 : HDD Security Settings

### Set User Password

Set HDD user password.

\*\*\* Advisable to power cycle system after setting hard disk passwords \*\*\*

Discard or save changes option in setup does not have any impact on HDD when password is set or removed. If the 'Set HDD User Password' option is gray, do power cycle to enable the option again.

## 4.5.2 Security Boot

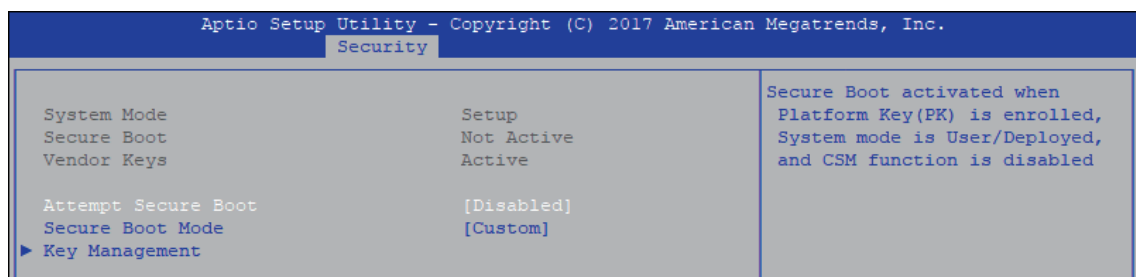

Figure 4-5-2 : Security Boot Settings

### Attempt Secure Boot

Secure Boot activated when Platform Key (PK) is enrolled, System mode is User/Deployed, and CSM function is disabled.

### Secure Boot Mode

Secure Boot mode selector Standard/Custom.

In custom mode Secure Boot Variables can be configured without authentication

### Key Management

Enables expert users to modify Secure boot policy variables without full authentication

## 4.6 Boot

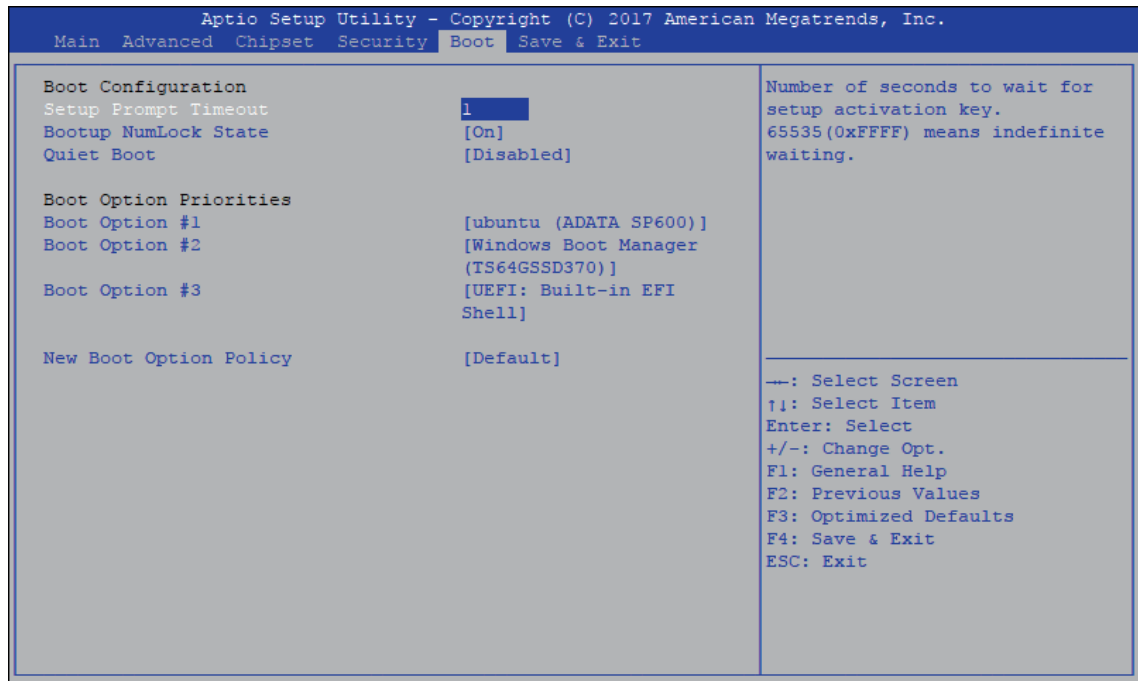

Figure 4-6 : BIOS Boot Menu

### Setup Prompt Timeout

Number of seconds to wait for setup activation key. 65535 (0xFFFF) means indefinite waiting.

### Bootup NumLock State

Select the keyboard NumLock state.

### Quiet Boot

Enables or disables Quiet Boot option.

### Boot Option

Sets the system boot order.

### New Boot Option Policy

Controls the placement of newly detected UEFI boot options.

### Hard Drive BBS Priorities

Set the order of the Legacy devices in this group.

## 4.7 Save & Exit

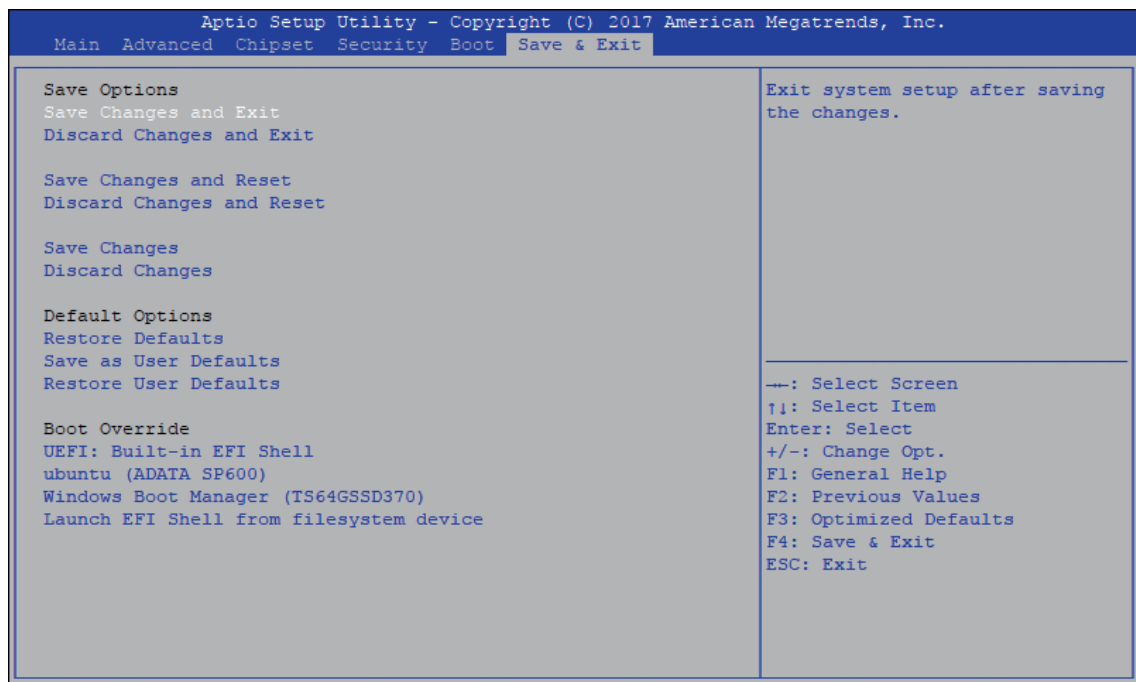

Figure 4-7 : BIOS Save and Exit Menu

### Save Changes and Exit

Exit system setup after saving the changes.

### Discard Changes and Exit

Exit system setup without saving any changes.

### Save Changes and Reset

Reset the system after saving the changes.

### Discard Changes and Reset

Reset system setup without saving any changes.

### Save Changes

Save Changes done so far to any of the setup options.

### Discard Changes

Discard Changes done so far to any of the setup options.

### Default Options

Restore Defaults

Restore/Load Default values for all the setup options.

### Save as User Defaults

Save the changes done so far as User Defaults.

### Restore User Defaults

Restore the User Defaults to all the setup options



# A

## APPENDIX A : Isolated DIO Guide

### A.1 Function Description

The ECX-1300/ECX-1400 offers a 16-bit Non-Isolated DIO/two 16-bit Isolated DIO 20-pin terminal block connector, a watchdog timer, and a 4-port POE.

Isolated DIO pins are fix by Hardware design that cannot change in/out direction in runtime process.

DIO definition is shown below :

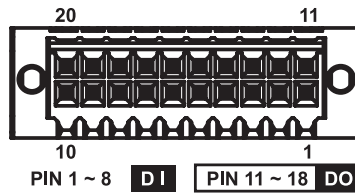

Pin No.	Isolated DIO	Non-Isolated DIO Definition	Pin No.	Isolated DIO Definition	Non-Isolated DIO Definition
1	DI 0	DIO 0	11	DO 0	DIO 8
2	DI 1	DIO 1	12	DO 1	DIO 9
3	DI 2	DIO 2	13	DO 2	DIO 10
4	DI 3	DIO 3	14	DO 3	DIO 11
5	DI 4	DIO 4	15	DO 4	DIO 12
6	DI 5	DIO 5	16	DO 5	DIO 13
7	DI 6	DIO 6	17	DO 6	DIO 14
8	DI 7	DIO 7	18	DO 7	DIO 15
9	DI COM	NC	19	DIO_GND	DIO_GND
10	DIO_GND	DIO_GND	20	External VDC	NC

POE definition is shown below :

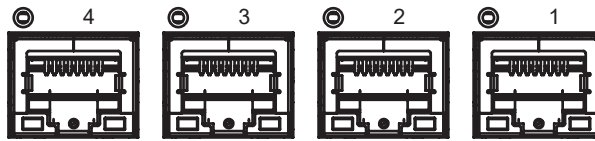

Port No.	Definition	Port No.	Definition
1	POE 0	3	POE 2
2	POE 1	4	POE 3

Do NOT use these functions in below :

1. PE-2000 : DIO1 (ID = 0), POE
2. PE-3000 : POE
3. UE-1000 : USB (ID = 0)

## A.2 Isolated DIO Signal Circuit

DI reference circuit :

Sink Mode  
(NPN)

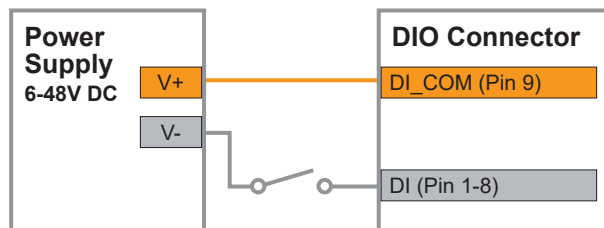

Source Mode  
(PNP)

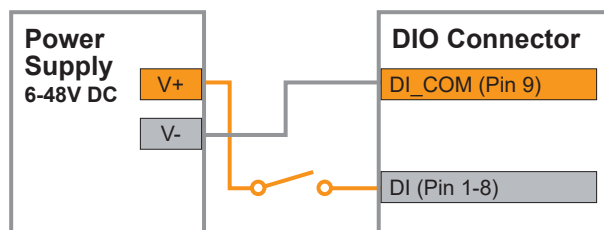

DO reference circuit :

Sink Mode  
(NPN, Default)

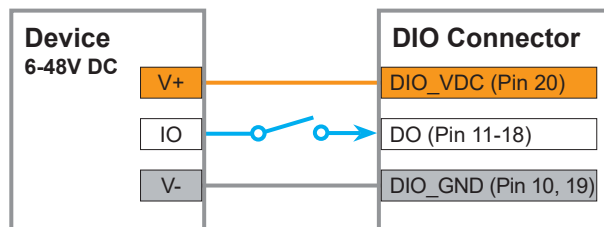

Source Mode  
(PNP)

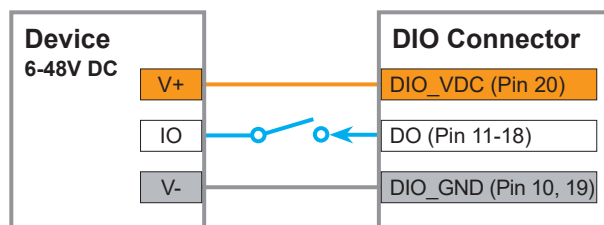

## A.3 Software Package Contain

Distribution folder include x32 and x64 versions, use batch file for installation.

There are included as fallowed :

Win7\_32.bat :

Installation for 32-bit driver

Win7\_64.bat :

Windows update package which driver required (need to restart), and

Installation for 64-bit driver

Win8\_32.bat, Win8\_64.bat :

Installation for driver, and guideline to Framework 3.5 distribution for sample

Win10\_32.bat, and Win10\_64.bat

Installation for driver, and

installation to Framework 3.5 distribution for sample

Uninstall\_32.bat, and Uninstall\_64.bat :

Uninstallation for driver

Run batch file as Administrator.

Support Windows 7 above.

Make sure Windows version before installation.

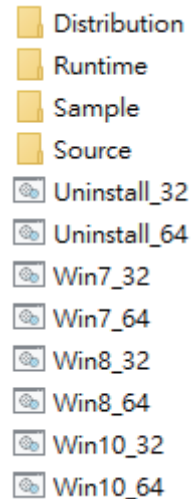

Runtime folder include head file for software developer or System Integration.

Sample folder include sample program, driver library, and API library.

Source folder include sample program source code that compile on Visual Studio 2008.

## A.4 Sample

Sample folder include x32 and x64 versions, as shown below :

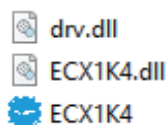

Sample ECX1K2.exe, as shown below :

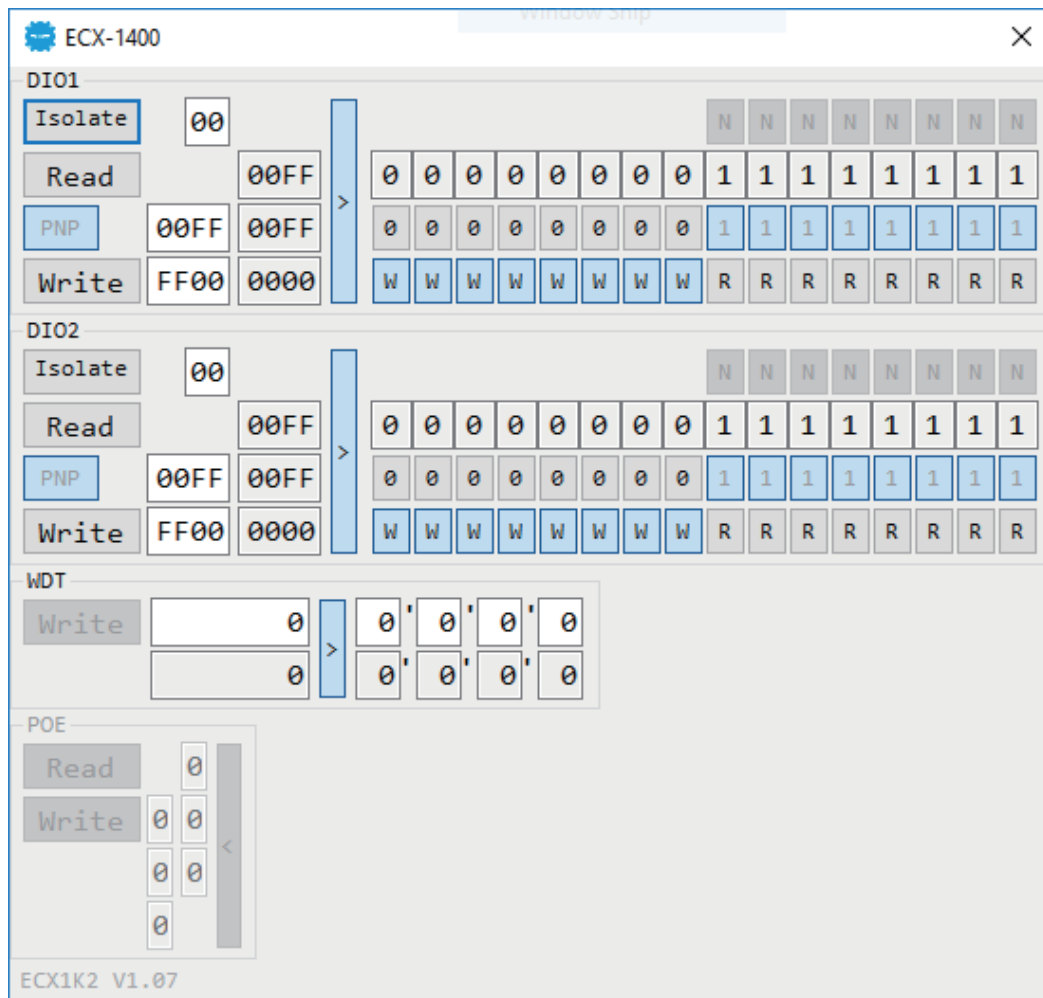

### DIO1/DIO2 group :

Isolate check button :

DIO type of DIO configuration, isolated/non-isolated.

Read button :

Set DIO configuration to get DI/DIO input state.

DO type check button :

User setting, DO type of DIO configuration to setup 8 pins - Source/Sink.

Use for Write (DO) button activate.

Write button :

Set DIO configuration to set DO/DIO output state.

DI preference text :

User setting, DI type of DIO configuration by hexadecimal bitmask - Source/Sink.

Use for Read (DI) button activate.

DO/DIO output text :

User setting, DO/DIO output state by hexadecimal bitmask - on/off.

Use for Write button activate.

DO/DIO writable text :

User setting, DO/DIO writable of DIO configuration by hexadecimal bitmask - yes/no.

Use for Read (DIO)/Write button activate.

DI/DIO input text (read only):

DI/DIO input state by hexadecimal bitmask - on/off.

Use for Read button activate.

DO/DIO text (read only):

DO/DIO output state with input state (DIO) and configuration.

Use for Write button activate.

DO/DIO output text (read only):

DO/DIO output state with configuration.

Use for Write button activate.

DI type pin check button (pin 8 ~ pin 1):

User setting, DI pin type of DIO configuration - Source/Sink.

DI/DIO input pin texts (read only, pin 8 ~ pin 1/pin 18 ~ pin 11, pin 8 ~ pin 1):

DI/DIO input pin state

Use for Read button activate.

DO/DIO output pin check button (pin 18 ~ pin 11/pin 18 ~ pin 11, pin 8 ~ pin 1):

User setting, DO/DIO output pin state

Use for Write button activate.

DO/DIO pin writable check button (pin 18 ~ pin 11/pin 18 ~ pin 11, pin 8 ~ pin 1):

User setting, DO/DIO pin writable of DIO configuration.

Use for Read (DIO)/Write button activate.

### **WDT group :**

Write button :

Set WDT when WDT setup text is valid.

Stop button :

Cancel WDT and counting.

Use after Write button action.

WDT setup text :

User setting, WDT value, unit : second.

Use for Write button activate.

WDT counting text (read only) :

WDT counting by program timer after set WDT.

Shown after Write button action.

WDT setup day format texts (user setting) :

User setting, WDT value, format : day'hour'minute'second.

WDT counting day format text (read only) :

WDT counting, format : day'hour'minute'second.

### **POE group :**

Read button :

Set POE configuration to get POE state.

Write button :

Set POE configuration to set POE state.

POE output text :

User setting, POE output state by hexadecimal bitmask - on/off.

Use for Write button activate.

POE writable text :

User setting, POE writable of POE configuration by hexadecimal bitmask - yes/no.

Use for Write button activate.

POE mode text :

User setting, POE mode of POE configuration by hexadecimal bitmask - Auto/Manual.

Use for Write button activate.

POE input text (read only) :

POE input state by hexadecimal bitmask - on/off.

Use for Read button activate.

POE text (read only) :

POE output state with input state and configuration.

Use for Write button activate.

POE output text (read only) :

POE output state with configuration.

Use for Write button activate.

POE input port texts (read only, port 4 ~ port 1) :

POE input port state

Use for Read button activate.

POE output port check button (port 4 ~ port 1) :

User setting, POE output port state

Use for Write button activate.

POE port writable check button (port 4 ~ port 1) :

User setting, POE port writable of POE configuration.

Use for Write button activate.

POE port mode check button (port 4 ~ port 1) :

User setting, POE port mode of POE configuration.

Use for Write button activate.

# B

## APPENDIX B : Software Functions

### B.1 Driver API Guide

In Runtime folder, on ECX1K4.h :

  \_DLL\_IMPORT\_ definition is used on LoadLibrary API for ECX1K4.dll.

  ECX1K4\_EXPORTS definition is used on ECX1K4.dll building.

  Otherwise, that is used to compile with ECX1K4.lib.

#### **BOOL Initial (BYTE Isolate\_Type, BYTE DIO\_NPN)**

Initial machine for DIO, watchdog timer, and POE

  Isolate\_Type : DIO type

    1 : Isolated DIO;

    0 : Non-Isolated DIO

  DIO\_NPN : DI/DO type

    1 : PNP (Source) mode for European rule;

    0 : NPN (Sink) mode for Japanese rule

Return :

  TRUE (1) : Success;

  FALSE (0) : Fail (Driver not exists, or initial error (version is too old, or machine not match))

#### **BOOL GetDIO1Config (BYTE \*Isolate\_Type, BYTE \*DI\_NPN, BYTE \*DO\_NPN, WORD \*Mask)**

#### **BOOL GetDIO2Config (BYTE \*Isolate\_Type, BYTE \*DI\_NPN, BYTE \*DO\_NPN, WORD \*Mask)**

Get DIO configuration (by variable)

  Isolate\_Type : DIO type

    1 : Isolated DIO;

    0 : Non-Isolated DIO

  DI\_NPN ([7:0]) : DI type, pin setting by hexadecimal bitmask

    1 : PNP (Source) mode for European rule;

    0 : NPN (Sink) mode for Japanese rule

  DO\_NPN : DO type

    1 : PNP (Source) mode for European rule;

    0 : NPN (Sink) mode for Japanese rule

  Mask ([15:0]) : In/Out, pin setting by hexadecimal bitmask

    1 : Output;

    0 : Input

Return :

  TRUE (1) : Success;

  FALSE (0) : Fail (Initial error, or call by pointer error, or hardware problem)

**BOOL SetDIO1Config (BYTE Isolate\_Type, BYTE DI\_NPN, BYTE DO\_NPN, WORD Mask)**

**BOOL SetDIO2Config (BYTE Isolate\_Type, BYTE DI\_NPN, BYTE DO\_NPN, WORD Mask)**

Set DIO configuration

Isolate\_Type : DIO type

1 : Isolated DIO;

0 : Non-Isolated DIO

DI\_NPN ([7:0]) : DI type, pin setting by hexadecimal bitmask

1 : PNP (Source) mode for European rule;

0 : NPN (Sink) mode for Japanese rule

DO\_NPN : DO type

1 : PNP (Source) mode for European rule;

0 : NPN (Sink) mode for Japanese rule

Mask ([15:0]) : In/Out, pin setting by hexadecimal bitmask

1 : Output;

0 : Input

Return :

TRUE (1) : Success;

FALSE (0) : Fail (Initial error, or hardware problem)

**BOOL GetDI1 (BYTE \*DI)**

**BOOL GetDI2 (BYTE \*DI)**

Get isolated DIO input (DI)

DI ([7:0]) : Input state, pin setting by hexadecimal bitmask

1 : High;

0 : Low

Return :

TRUE (1) : Success;

FALSE (0) : Fail (Initial error, or call by pointer error, or hardware problem)

**BOOL GetDO1 (BYTE \*DO)**

**BOOL GetDO2 (BYTE \*DO)**

Get isolated DIO output (DO)

DO ([7:0]) : Output state, pin setting by hexadecimal bitmask

1 : High;

0 : Low

Return :

TRUE (1) : Success;

FALSE (0) : Fail (Initial error, or call by pointer error, or hardware problem)

**BOOL SetDO1 (BYTE DO)**

**BOOL SetDO2 (BYTE DO)**

Set isolated DIO output (DO)

DO ([7:0]) : Output state, pin setting by hexadecimal bitmask

1 : High;

0 : Low

Return :

TRUE (1) : Success;

FALSE (0) : Fail (Initial error, or hardware problem)



**BOOL GetDIO1 (WORD \*DI)****BOOL GetDIO2 (WORD \*DI)**

Get non-isolated DIO input (DIO input)

DI ([15:0]) : Input state, pin setting by hexadecimal bitmask

1 : High;

0 : Low

Return :

TRUE (1) : Success;

FALSE (0) : Fail (Initial error, or call by pointer error, or hardware problem)

**BOOL SetDIO1 (WORD DO)****BOOL SetDIO2 (WORD DO)**

Set non-isolated DIO output (DIO output)

DO ([15:0]) : output state, pin setting by hexadecimal bitmask

1 : High;

0 : Low

Return :

TRUE (1) : Success;

FALSE (0) : Fail (Initial error, or hardware problem)

**BOOL GetWDT (DWORD \*WDT)**

Get watchdog timer setup

WDT : watchdog timer setup

Unit : second. (Range : 0 ~ 65535 sec, 1093 ~ 65535 min (=65580 ~ 3932100 sec))

Return :

TRUE (1) : Success;

FALSE (0) : Fail (Initial error, or call by pointer error, or hardware problem)

**BOOL SetWDT (DWORD WDT)**

Set watchdog timer setup

WDT : watchdog timer setup

Unit : second. (Range : 1 ~ 65535 sec, 1093 ~ 65535 min (=65580 ~ 3932100 sec))

Return :

TRUE (1) : Success;

FALSE (0) : Fail (Initial error, or setup 0 error, or hardware problem)

**BOOL CancelWDT ()**

Cancel watchdog timer

Return :

TRUE (1) : Success;

FALSE (0) : Fail (Initial error, or hardware problem)

**BOOL GetPOEConfig (BYTE \*Auto, BYTE \*Mask)**

Get POE configuration (by variable)

Auto ([3:0]) : Auto mode, pin setting by hexadecimal bitmask

1 : Auto;

0 : Manual

Mask ([3:0]) : DC Enable/Disable, pin setting by hexadecimal bitmask

1 : Enable;

0 : Disable

Return :

TRUE (1) : Success;

FALSE (0) : Fail (Initial error, or call by pointer error, or hardware problem)

### **BOOL SetPOEConfig (BYTE Auto, BYTE Mask)**

Set POE configuration

Auto ([3:0]) : Auto mode, pin setting by hexadecimal bitmask

1 : Auto;

0 : Manual

Mask ([3:0]) : DC Enable/Disable, pin setting by hexadecimal bitmask

1 : Enable;

0 : Disable

Return :

TRUE (1) : Success;

FALSE (0) : Fail (Initial error, or out of range error, or hardware problem)

### **BOOL GetPOE (BYTE \*POE)**

Get POE input

POE ([3:0]) : POE state, pin setting by hexadecimal bitmask

1 : On;

0 : Off

Return :

TRUE (1) : Success;

FALSE (0) : Fail (Initial error, or call by pointer error, or hardware problem)

### **BOOL SetPOE (BYTE POE)**

Set POE output

POE ([3:0]) : POE state, pin setting by hexadecimal bitmask

1 : On;

0 : Off

Return :

TRUE (1) : Success;

FALSE (0) : Fail (Initial error, or out of range error, or hardware problem)

# C

## APPENDIX C : RAID Functions

### D.1.1 SATA Mode for RAID

Please select SATA Device to RAID mode on BIOS menu.

Advanced → SATA Configuration → SATA Mode Selection → RAID (Skylake platform)/Intel RST Premium (Kaby Lake/Coffee Lake platform)

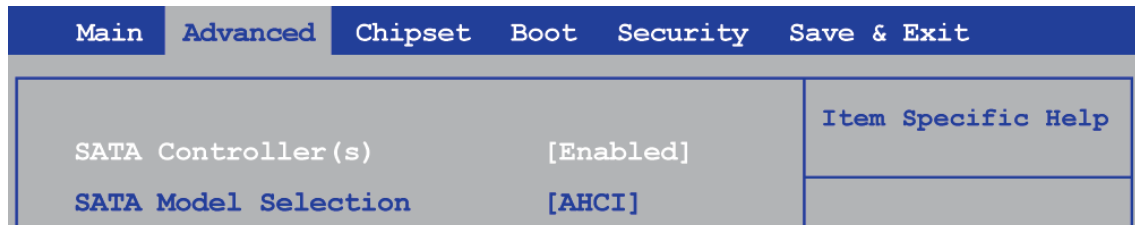

### D.1.2 UEFI Mode for RAID

1. Please select SATA device to RAID mode on BIOS menu.

Advanced → SATA Configuration → SATA Mode Selection → RAID (Skylake platform)/Intel RST Premium (Kaby Lake/Coffee Lake platform)

2. Please select Software Feature Mask Configuration on BIOS menu.

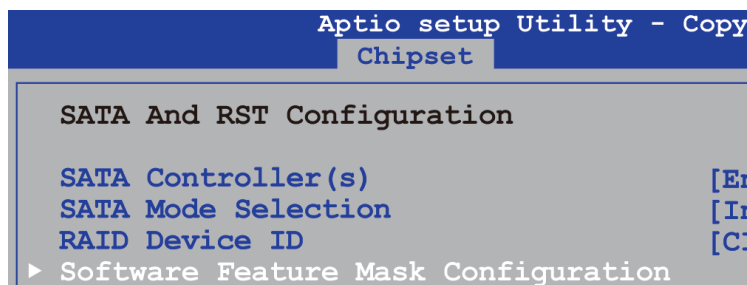

3. Use RST Legacy OROM → Disabled → Save Changes and Reset.

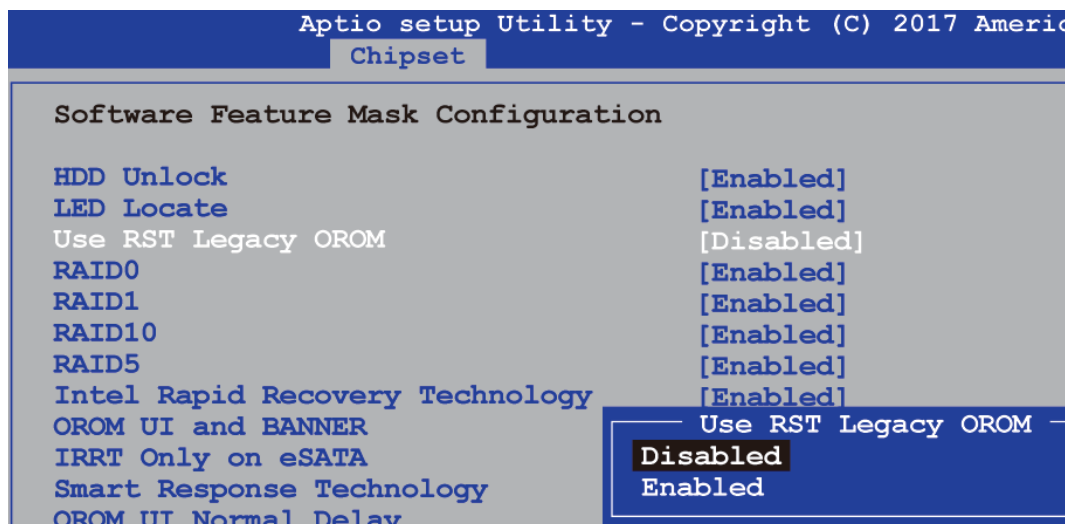

4. Into BIOS menu again, select Intel(R) Rapid Storage Technology on BIOS menu.

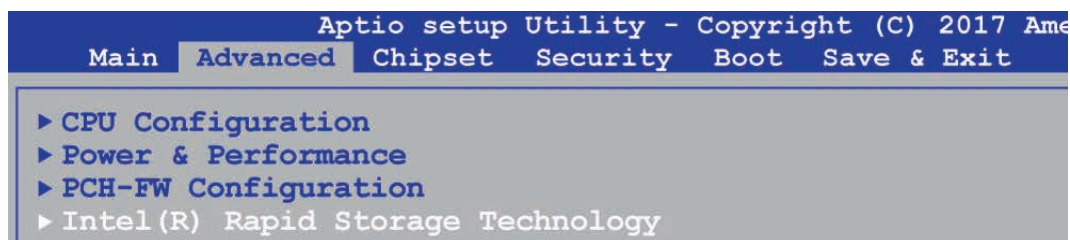

5. Select Create RAID Volume on BIOS menu.

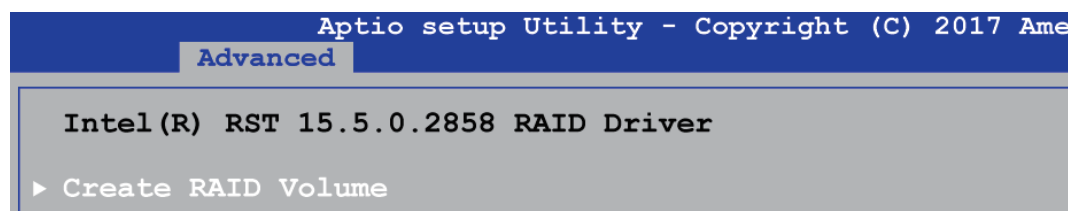

6. Select disks to create RAID Volume then Save Changes and Reset to install OS with EFI mode.

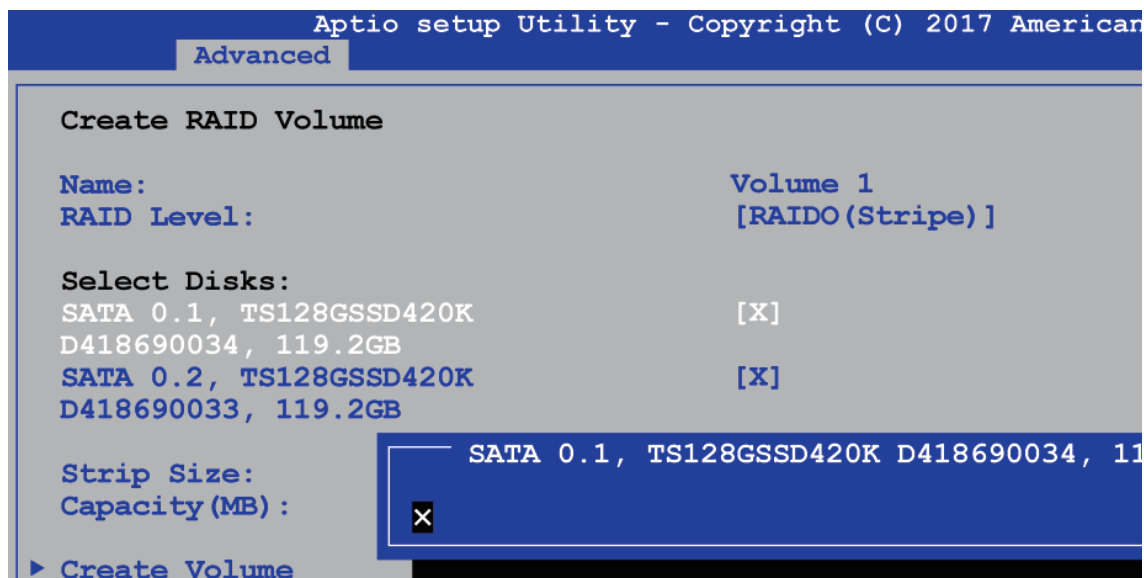

## C.2 OS Installation

ECX-1400 is featured with eight SATA, including four internal SATA, two mSATA, one M.2 and one CFast.

We used SATA for Windows 10 OS installation as an example.

## C.3 To Install All Device Drivers of the System

The instructions are as follows :

1. Install Chipset driver
2. Install Network driver
3. Install ME driver (if available)
4. Install Audio driver
5. Install VGA driver

## C.4 To Install "Intel Rapid Storage Technology" Software

You can get the latest information and the software directly from Intel website.

[http://www.intel.com/p/en\\_US/support/highlights/chpsts/imsm](http://www.intel.com/p/en_US/support/highlights/chpsts/imsm)

The RAID environment has been done if you completed the steps above.

## C.5 To Insert SATA HDD for RAID 1

Please note, you can use two SATA ports for SATA HDD, except for mSATA slot.

## C.6 To Create RAID Volume on "Rapid Storage Technology" Software

ECX-1400/1300 is featured with four SATA HDD's for RAID volume, so there are three options to choose on this page. Let's take RAID 1 as an example, select "RAID 1"

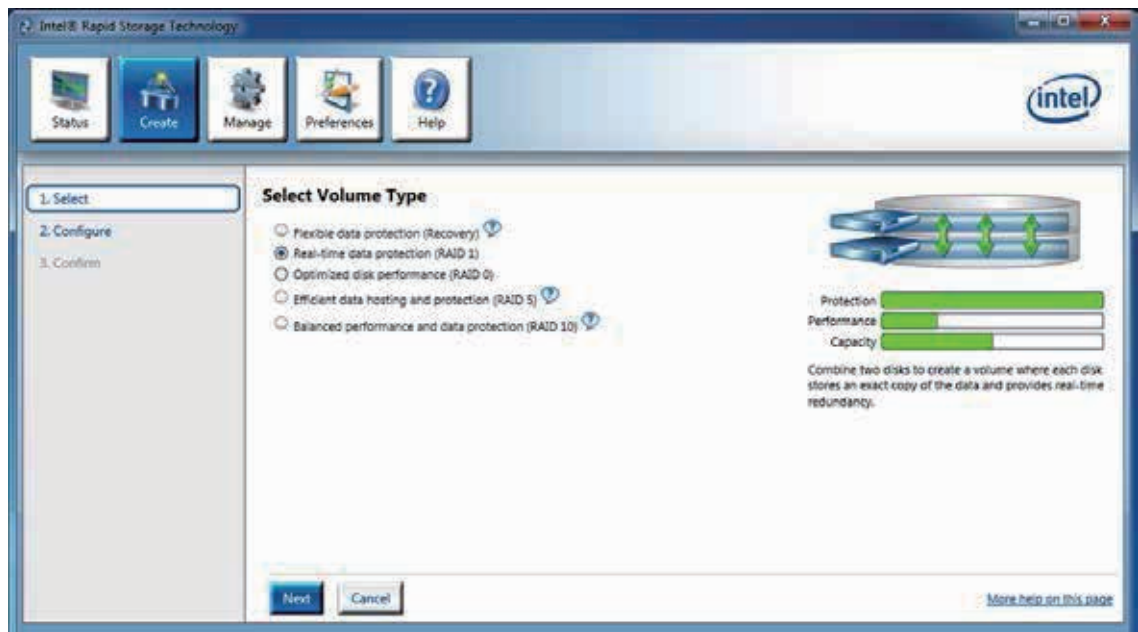

## C.7 Disk Management : Partition the Disk

After RAID 1 volume is created, you can see the figure of SATA device allocation.

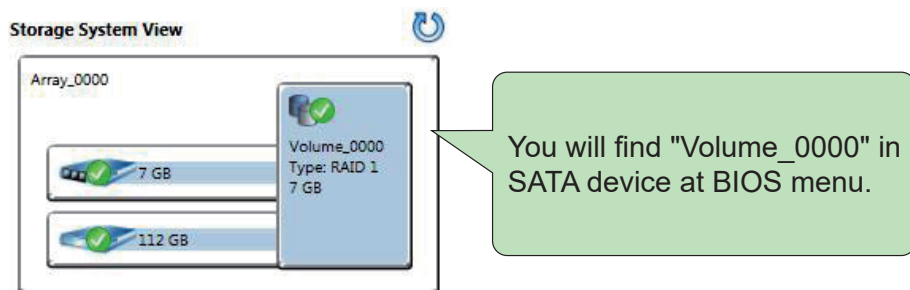

To start disk management tool, select "initialize disk".

Then add "Logical Device" for Windows access.

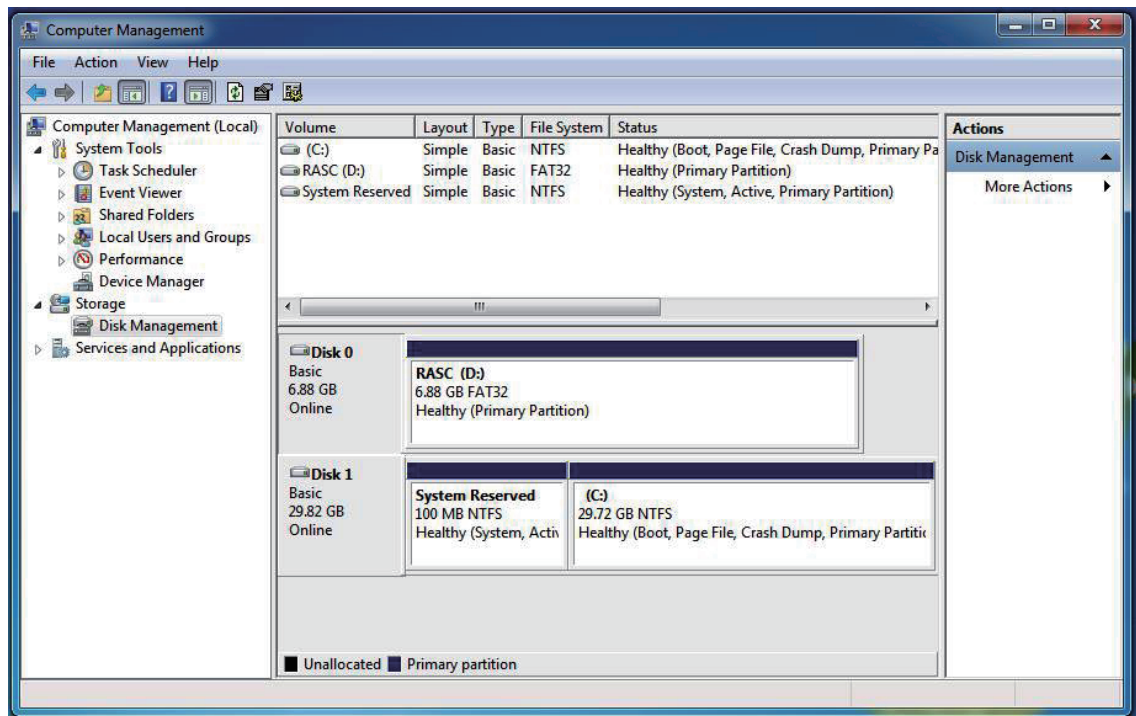

## C.8 If One SATA HDD on RAID Volume is Out-of-use

After RAID 1 volume is created, you can see the figure of SATA device allocation.

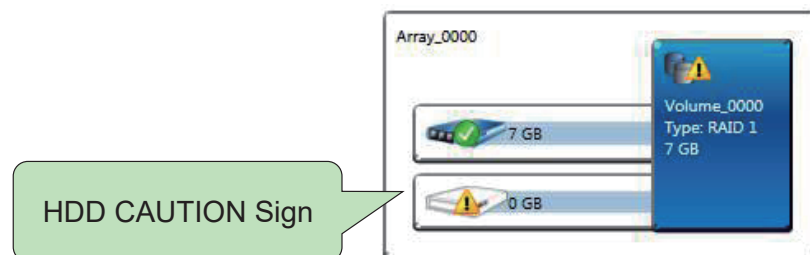

## C.9 Recovery and Auto Rebuild When Use the **SAME** RAID HDD

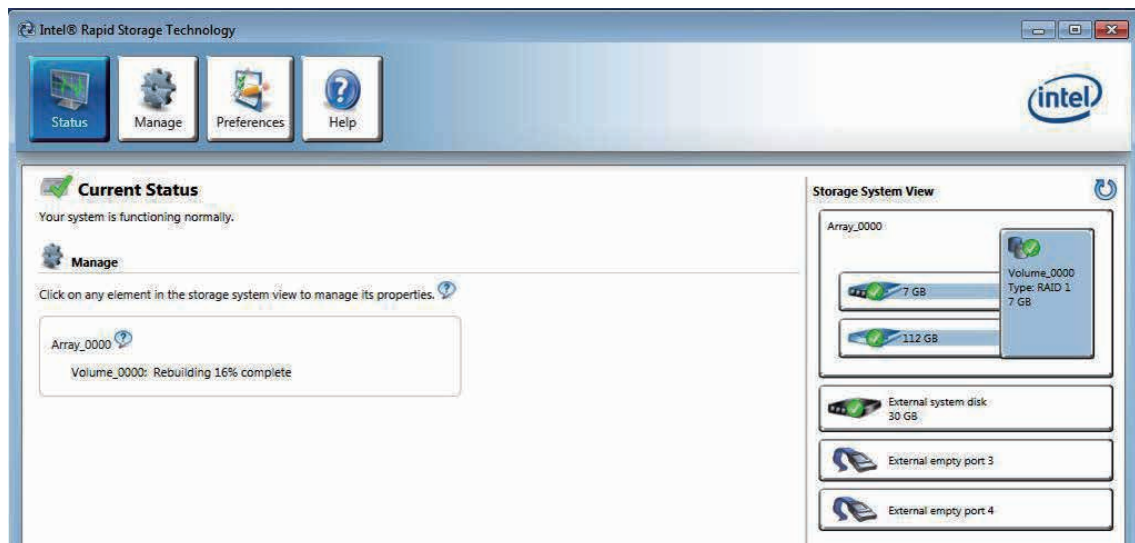

## C.10 Recovery and Auto Rebuild When Use **DIFFERENT** RAID HDD

A warning will pop-up to ask you if the disk is not a member of the original RAID volume.

If you press "Rebuild", it will replace the broken SATA HDD to the last SATA HDD of RAID volume.

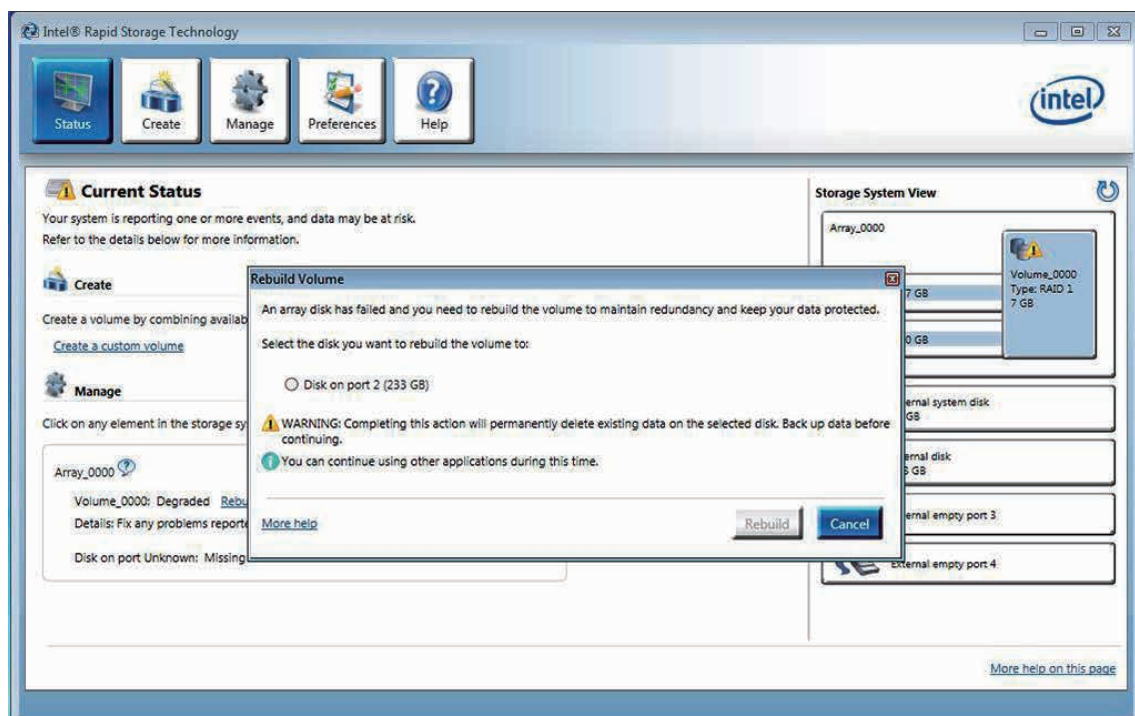



# D

## APPENDIX D : Power Consumption

Testing Board	ECX-1400
RAM	32GB * 2
USB-1	USB Microsoft Wired Keyboard 600
USB-2	USB Mouse HP G1K28AA
USB-3	USB Flash Transcend 3.0 8GB
USB-4	USB Flash Transcend 3.0 8GB
USB-5	USB Flash Kingston 3.0 16GB
USB-6	USB Flash Kingston 3.0 32GB
CFAST	Transcend CFX600 CFAST 128GB
SATA 0	Transcend SATA SSD420 128GB
SATA 1	Seagate HDD 500GB
LAN 1 (i219)	1.0Gbps
LAN 2 (i210)	1.0Gbps
Graphics output	DVI
Power plan	Balance (Windows10 Power plan)
Power Source	Chroma 62006P-100-25
Test Program-1	BurnInTest
Test Program-2	FurMark

## D.1 Intel® Core™ i7-8700T (8M Cache, 2.40GHz)

Power on and boot to Win 10 (64-bit)

CPU	Power Input	Power on and boot to Win 10 (64-bit)					
		Standby Mode		Sleep Mode		idle status CPU usage less 3%	
		Max Current	Max Consumption	Max Current	Max Consumption	Max Current	Max Consumption
Core™ i7-8700T	6V	0.670A	04.02W	0.766A	04.60W	4.149A	24.89W
Core™ i7-8700T	9V	0.374A	03.36W	0.488A	04.39W	2.149A	19.34W
Core™ i7-8700T	12V	0.309A	03.71W	0.393A	04.71W	1.634A	19.60W
Core™ i7-8700T	24V	0.320A	07.68W	0.353A	08.46W	1.238A	29.72W
Core™ i7-8700T	36V	0.315A	11.33W	0.333A	11.99W	0.837A	30.14W

CPU	Power Input	Power on and boot to Win10 (64-bit)			
		Run 100% CPU usage with 2D		Run 100% CPU usage with 3D	
		Max Current	Max Consumption	Max Current	Max Consumption
Core™ i7-8700T	6V	7.121A	42.73W	9.143A	54.86W
Core™ i7-8700T	9V	4.788A	43.10W	6.594A	59.35W
Core™ i7-8700T	12V	3.774A	45.29W	4.345A	52.13W
Core™ i7-8700T	24V	2.071A	49.71W	2.782A	66.77W
Core™ i7-8700T	36V	1.435A	51.65W	1.658A	59.67W

## D.2 Intel® Core™ i7-8700 (12M Cache, 3.20GHz)

Power on and boot to Win 10 (64-bit)

CPU	Power Input	Power on and boot to Win 10 (64-bit)					
		Standby Mode		Sleep Mode		idle status CPU usage less 3%	
		Max Current	Max Consumption	Max Current	Max Consumption	Max Current	Max Consumption
Core™ i7-8700	6V	0.604A	03.62W	0.882A	05.29W	3.322A	19.93W
Core™ i7-8700	9V	0.445A	04.01W	0.559A	05.03W	2.138A	19.25W
Core™ i7-8700	12V	0.368A	04.41W	0.452A	05.42W	1.656A	19.87W
Core™ i7-8700	24V	0.331A	07.94W	0.386A	09.27W	1.071A	25.69W
Core™ i7-8700	36V	0.326A	11.72W	0.353A	12.72W	0.816A	29.38W

CPU	Power Input	Power on and boot to Win10 (64-bit)			
		Run 100% CPU usage with 2D		Run 100% CPU usage with 3D	
		Max Current	Max Consumption	Max Current	Max Consumption
Core™ i7-8700	6V	9.537A	57.22W	12.126A	72.76W
Core™ i7-8700	9V	6.364A	57.28W	8.232A	74.08W
Core™ i7-8700	12V	4.794A	57.53W	6.097A	73.16W
Core™ i7-8700	24V	2.629A	63.10W	3.218A	77.23W
Core™ i7-8700	36V	1.885A	67.86W	2.431A	87.53W

## D.3 Intel® Xeon® E-2176G (12M Cache, up to 4.70GHz)

Power on and boot to Win 10 (64-bit)

CPU	Power Input	Power on and boot to Win 10 (64-bit)					
		Standby Mode		Sleep Mode		idle status CPU usage less 3%	
		Max Current	Max Consumption	Max Current	Max Consumption	Max Current	Max Consumption
Xeon® E-2176G	6V	0.613A	03.68W	0.915A	05.49W	3.204A	19.22W
Xeon® E-2176G	9V	0.449A	04.04W	0.577A	05.19W	2.128A	19.15W
Xeon® E-2176G	12V	0.368A	04.41W	0.464A	05.56W	1.626A	19.51W
Xeon® E-2176G	24V	0.332A	07.96W	0.388A	09.32W	1.054A	25.28W
Xeon® E-2176G	36V	0.324A	11.67W	0.306A	11.03W	0.823A	29.61W

CPU	Power Input	Power on and boot to Win10 (64-bit)			
		Run 100% CPU usage with 2D		Run 100% CPU usage with 3D	
		Max Current	Max Consumption	Max Current	Max Consumption
Xeon® E-2176G	6V	12.925A	77.55W	15.803A	94.82W
Xeon® E-2176G	9V	8.721A	78.49W	9.501A	85.50W
Xeon® E-2176G	12V	6.005A	72.05W	8.597A	103.16W
Xeon® E-2176G	24V	3.346A	80.31W	4.111A	98.66W
Xeon® E-2176G	36V	2.281A	82.11W	2.653A	95.50W

## D.4 Intel® Core™ i7-8700 Add GTX-1050 Graphics Card

Power on and boot to Win 10 (64-bit)

CPU	Power Input	Standby Mode		Power on and boot to Win 10 (64-bit)			
				Sleep Mode		idle status CPU usage less 3%	
		Max Current	Max Consumption	Max Current	Max Consumption	Max Current	Max Consumption
Core™ i7-8700	24V	0.308A	07.38W	0.371A	08.90W	1.292A	31.00W
Core™ i7-8700	36V	0.302A	10.86W	0.344A	12.39W	1.061A	38.19W

CPU	Power Input	Power on and boot to Win10 (64-bit)			
		Run 100% CPU usage with 2D		Run 100% CPU usage with FurMark	
		Max Current	Max Consumption	Max Current	Max Consumption
Core™ i7-8700	24V	2.942A	70.60W	5.005A	120.11W
Core™ i7-8700	36V	2.075A	74.71W	3.504A	126.13W

## D.5 Intel® Core™ i7-8700 Add GTX-1070 Graphics Card

Power on and boot to Win 10 (64-bit)

CPU	Power Input	Standby Mode		Power on and boot to Win 10 (64-bit)			
				Sleep Mode		idle status CPU usage less 3%	
		Max Current	Max Consumption	Max Current	Max Consumption	Max Current	Max Consumption
Core™ i7-8700	24V	0.310A	07.43W	0.376A	09.02W	1.542A	37.01W
Core™ i7-8700	36V	0.304A	10.93W	0.348A	12.53W	1.166A	41.96W

CPU	Power Input	Power on and boot to Win10 (64-bit)			
		Run 100% CPU usage with 2D		Run 100% CPU usage with FurMark	
		Max Current	Max Consumption	Max Current	Max Consumption
Core™ i7-8700	24V	3.113A	74.70W	9.035A	216.85W
Core™ i7-8700	36V	2.197A	79.08W	5.879A	211.66W

# E

## APPENDIX E : Supported Memory & Storage List

### E.1 Test Item

Testing Board	ECX-1400
Memory Test	version : 5.1
BurnInTest	V8.1

Channel	Memtest	Bunin	Flash BIOS	Remove Battery
*2	PASS	PASS	PASS	PASS
*1 (Socket 1)	PASS	PASS	N/A	PASS
*1 (Socket 2)	PASS	PASS	N/A	PASS

### E.2 Supported Non-ECC Memory List

Brand	Info	Test Temp. (Celsius)
Innodisk 16G DDR4 2400 SODIMM	M4S0-AGS1OCSJ-H03	25°C
		25°C
Innodisk 4G DDR4 2400 SODIMM	M4S0-4GSSN5SJ-H03	25°C
		25°C
Innodisk 16G DDR4 2666 W/T SODIMM	M4S0-AGS1O5IK-H03	25°C
		25°C
Innodisk 16G DDR4 2666 SODIMM	M4S0-AGS1OCIK-H03	25°C
		25°C
Innodisk 8G DDR4 2666 W/T SODIMM	M4S0-8GS1N5IK-H03	25°C
		25°C
Innodisk 8G DDR4 2666 W/T SODIMM	M4S0-8GSSOCIK-H03	25°C
		25°C
Innodisk 4G DDR4 2666 W/T SODIMM	M4S0-4GSSN5IK-H03	25°C
		25°C
Innodisk 4G DDR4 2666 W/T SODIMM	M4S0-4GSSNCIK-H03	25°C
		25°C

Brand	Info	Test Temp. (Celsius)
MEMXPRO 16G DDR4 2666-19 SODIMM	D4SAGHLQHFI	25°C
		25°C
MEMXPRO 16G DDR4 2666-19 SODIMM	D4SAGHLQHFC-AH	25°C
		25°C
MEMXPRO 8G DDR4 2666-19 SODIMM	D4S8GHLQHEC-AH	25°C
		25°C
MEMXPRO 8G DDR4 2666-19 SODIMM	D4S8GHLQHEI	25°C
		25°C
ADATA 8G DDR4 2666 (19)	AD4S266638G19-BSSC	25°C
		25°C
ADATA 8G DDR4 2666 (19)	AD4S2666316G19-BSSC	25°C
		25°C
Kingston 16GB PC4-2666 CL19	KVR26S19DS8/16	25°C
		25°C
Kingston 8GB PC4-2666 CL19	KVR26S19S8/8	25°C
		25°C
Kingston 4GB PC4-2666 CL19	KVR26S19S6/4	25°C
		25°C
SLINK (MBG-JBM) 32G DDR4 2666	J4BGSS2G8QHXC	25°C
		25°C
SLINK (MBG-JBM) 32G DDR4 2666	J4BGSS2G8QHXI	25°C
		25°C
SLINK (MBG-JBM) 16G DDR4 2666	J4AGSH1G8QHFC	25°C
		25°C
SLINK (MBG-JBM) 8G DDR4 2666	J48GSH1G8QHEC	25°C
		25°C
MEMXPRO 16G DDR4 2666-19	D4SAGHLQHFI	25°C
		25°C
MEMXPRO 16G DDR4 2666-19	D4SAGHLQHFC-AH	25°C
		25°C
MEMXPRO 8G DDR4 2666-19	D4S8GHLQHEC-AH	25°C
		25°C
MEMXPRO 8G DDR4 2666-19	D4S8GHLQHEI	25°C
		25°C

### E.3 Supported ECC Memory List

Brand	Info	Test Temp. (Celsius)
Innodisk 16G DDR4 2400 SODIMM	M4D0-4GSSPCSJ-H03	25°C
		25°C
Innodisk 4G DDR4 2400 SODIMM	M4D0-AGS1Q5SJ-H03	25°C
		25°C
Innodisk 16G DDR4 2666 SODIMM W/T	M4S0-AGS1Q5IK-H03	25°C
		25°C
Innodisk 16G DDR4 2666 SODIMM W/T	M4S0-AGS1QCIK-H03	25°C
		25°C
Innodisk 8G DDR4 2666 SODIMM W/T	M4S0-8GS1P5IK-H03	25°C
		25°C
Innodisk 4G DDR4 2666 SODIMM W/T	M4S0-4GSSP5IK-H03	25°C
		25°C
Innodisk 4G DDR4 2666 SODIMM W/T	M4S0-4GSSPCIK-H03	25°C
		25°C
SLINK (MBG-JBM) 32G DDR4 2666	J4BGDS2G8QH KC	25°C
		25°C
SLINK (MBG-JBM) 32G DDR4 2666	J4BGDS2G8QH KI	25°C
		25°C
SLINK (MBG-JBM) 16G DDR4 2666	J4AGDH1G8QH KC	25°C
		25°C
SLINK (MBG-JBM) 8G DDR4 2666	J48GDH1G8QH JC	25°C
		25°C
MEMXPRO 16G DDR4 2466-19	D4DAGHLQH KC-AH	25°C
		25°C
MEMXPRO 16G DDR4 2466-19	D4DAGHLQH KI-AH	25°C
		25°C
MEMXPRO 8G DDR4 2666-19	D4D8GHLQH JI-AH	25°C
		25°C
MEMXPRO 8G DDR4 2666-19	D4D8GHLQH JC-AH	25°C
		25°C



## E.4 Supported Storage Device List

Type	Brand	Model	Capacity
mSATA	Transcend	mSATA TS64GMSA370	64GB
	Intel	Intel-310 SSDMAEMC080G2	80GB
	Innodisk	DEMSR-32GD06SW2QC	32GB
SSD	Intel	SSD E 5400s SSDSC2KR120H6	120GB
		SSD 540s SSDSC2KW120H6	120GB
	Innodisk	3MG2-P DGS25-64GD81BC1QC	64GB
	LITE-ON	K8-L1512	512GB
		K8-L1256	256GB
	Transcend	TS128GSSD420K	128GB
		SSD370 TS64GSSD370I	64GB
	Kingston	SUV400S37	120GB
	FORESEE	S903S128G	128GB
		S903S256G	256GB
	ADATA	ISSS332-128GM	128GB
ISSS332-256GM		256GB	
SATA HDD	Seagate	SDC001	500GB
CFast	Transcend	TS128GCFX600	128GB
	Innodisk	3ME4 DECFA-A28M41BC1DC-H03	128GB

\*\* If more help is needed, please contact Vecow Technical Support.\*\*



For further support information, please visit [www.vecow.com](http://www.vecow.com)

This document is released for reference purpose only.

All product offerings and specifications are subject to change without prior notice.

No part of this publication may be reproduced in any form or by any means, electric, photocopying, or recording, without prior authorization from the publisher.

The rights of all the brand names, product names, and trademarks belong to their respective owners.

© Vecow Co., Ltd. 2023. All rights reserved.